



General Industry



# AUTOMATIC SPRAY GUN

WA-200

WA-101

LPA-200

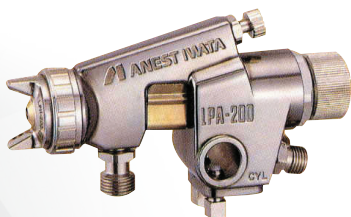
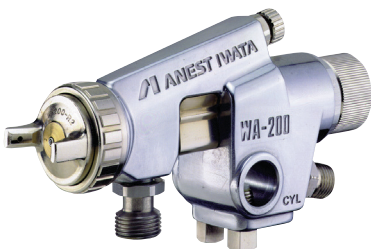



USE &  
MAINTENANCE  
INSTRUCTION  
MANUAL

EN IT FR ES PT DE SE









	Before use, adjustment or maintenance, it is important to read this instruction manual very carefully. This manual must be stored in a safe place for any future reference.
  II 2G X	This ANEST IWATA automatic spray guns kit complies to ATEX regulations ATEX 2014/34/EU.
Protection level: II 2 G X Suitable for using Zones 1 and 2. X marking: Any static electricity discharge from the spray gun is to be diverted to the ground via the conductive air hose as stipulated.	

	<b>ALWAYS OBSERVE WARNINGS AND CAUTIONS IN THIS INSTRUCTION MANUAL.</b>		
SYMBOL	WARNING	HAZARD LEVEL	CONSEQUENCE
	<b>WARNING</b>	POTENTIALLY HAZARDOUS SITUATION	DEATH OR SERIOUS INJURY
	<b>CAUTION</b>		MINOR TO MODERATE INJURY
	<b>IMPORTANT</b>		PROPERTY DAMAGE

## 1. TECHNICAL SPECIFICATIONS

MODELS	WA-200	WA-200 WB	WA-200 ZP	WA-101	WA-101 R	LPA-200
Max. working air pressure:	7.0 bar (100 PSI)					
Noise level (LAeqT)*:	81.2 dB(A)	76.8 dB(A)	79.0 dB(A)	78.7 dB(A)	62.8 dB(A)	76.9 dB(A)
Air nipple:	G1/4"					
Fluid nipple:	G1/4"	G1/4"	G3/8"	G1/4"	G1/4"	G3/8"
Max. Temperature:	Atmosphere 5 ~ 40 °C / Air-Fluid 5 ~ 43 °C					
* Measuring point: 1m backwards from gun, 1.6 m height.						

### 1.1 TECHNICAL DATA

MODELS							
<b>WA-200 WB</b>							
WA-200 WB-081P	0.8	WB1	1.6	200	340	360	470
WA-200 WB-101P	1.0			250			
WA-200 WB-121P	1.2			300			
WA-200 WB-141P	1.4						
WA-200 WB-161P	1.6						
<b>WA-200</b>							
WA-200-062	0.6	LV2	2.0	255	270	280	500
WA-200-084	0.8						
WA-200-104	1.0						
WA-200-124	1.2						
WA-200-154	1.5						
WA-200-082P	0.8	G2P	3.0	500	530	400	
WA-200-102P	1.0						
WA-200-122P	1.2	K2	3.0	270	330	340	
WA-200-152P	1.5						
WA-200-202P	2.0						
WA-200-202P	2.0	R2		400	360	320	
WA-200-251P	2.5	W1		500		330	
<b>WA-200 FLAT AND THIN® (Flat Pattern)</b>							
WA-200-066P FT	0.6	FT6	1.8	80	170	140	550
WA-200-086P FT	0.8			100	185	150	
WA-200-106P FT	1.0			120	200	160	
WA-200-126P FT	1.2			140	220	180	
<b>WA-200 ZP (For Abrasive Paint)</b>							
WA-200-151ZP	1.5	R1Z	3.5	760	500	370	470
WA-200-201ZP	2.0						
WA-200-251ZP	2.5						
<b>WA-101</b>							
WA-101-082P	0.8	E2P	3.0	150	270	190	460
WA-101-102P	1.0	E2P		200	270	220	
WA-101-101P	1.0	E1		100	90	140	
WA-101-132P	1.3	H2		250	260	230	
<b>WA-101 R (Round Pattern)</b>							
WA-101R-05P	0.5	RP	3.0	20	40	35	440
<b>LPA-200 HVLP</b>							
LPA-200-122P	1.2	G2	2.0	500	500	300	500
LPA-200-S5-12P	1.2	G2	2.0	250	560	250	

## 2. SAFETY WARNING

<b>FIRE AND EXPLOSION</b>	
<p><b>Never use the following HALOGENATED HYDROCARBON SOLVENTS:</b> which can cause cracks or dissolution of gun body (aluminium) due to chemical reaction. <b>UNSUITABLE SOLVENTS:</b> methyl chloride, dichloromethane, 1,2-dichloroethane, carbon tetrachloride, trichloroethylene, 1.1.1-trichloroethane.</p>	
<p><b>Sparks and open flames are strictly prohibited.</b> Paints can be highly flammable and can cause fire. Do not expose to open flames, electrical goods, cigarettes etc.</p>	
<p><b>Securely ground spray gun using conductive air hose.</b> (&lt;1MΩ). Always ensure that the spray gun is earthed correctly.</p>	
<b>PROTECTION OF HUMAN BODY</b>	
<p><b>Use in a well-ventilated site, using a spray booth.</b> Poor ventilation can cause organic solvent poisoning and fire.</p>	
<p><b>Always wear protective gear (safety glasses, mask, gloves) to avoid inflammation of eyes and skin.</b> In case of any physical discomfort, immediately seek medical advice.</p>	
<p><b>Wear earplugs if necessary.</b> Noise level can exceed 80 dB(A), depending on operating conditions and painting site.</p>	
<b>IMPROPER USE</b>	
<p><b>Never point gun towards people or animals.</b></p>	
<p><b>Never exceed maximum working pressure or Maximum Operating Temperature.</b></p>	
<p><b>Always release air and fluid pressure before cleaning, disassembling or servicing.</b> Otherwise, remaining pressure can cause bodily injury due to improper operation or scattering of cleaning liquid. In order to release pressure, first stop supply of compressed air and fluid to automatic spray gun. Next, supply only piston operating air and exhaust fluid by operating fluid needle, which results in automatic supply stop of all compressed air.</p>	
<p><b>Tip of fluid needle set has a sharp point.</b> Do not touch the tip during maintenance to avoid accidents.</p>	
<p><b>Never use this gun to spray foods or chemicals.</b> Otherwise, foreign substance, could cause corrosion of fluid passages which could adversely affect health.</p>	
<p><b>Never alter this spray gun,</b> to avoid insufficient performance and damage.</p>	
<p><b>If something goes wrong, immediately stop operation and find the cause. Do not use again, until you have solved the problem.</b></p>	
<p><b>Do not enter working areas, where robots, reciprocators, etc. are used, until they have been turned off.</b> Otherwise, they could cause injury.</p>	

## 3. HOW TO CONNECT

	<p><b>Use clean air filtered through air dryer and air filter.</b></p>
	<p><b>When using this automatic gun for the first time after purchase, spray cleaner to clean fluid passages and remove rust preventive oil.</b></p>
	<p><b>Use three-way solenoid valve of more than ø 4 inner dia. cross-sectional area and air hose of over ø 6 inner dia. and less than 10m length. Small dia. of solenoid valve and longer air hose between three-way solenoid valve and gun can cause delay in operation.</b></p>
	<p><b>Firmly fix hose to spray gun, to avoid that the disconnection of hose during operation, can cause bodily injury.</b></p>
1.	Fit the gun on fitting stay, aim at spraying target and fix it, by fixing bolt.
2.	Connect atomizing air hose to atomizing air side (CAP marked side) and operating air hose to operating air side (CYL marked side) tightly.
3.	Connect fluid hose to fluid nipple tightly.
4.	Flush the gun fluid passages with a compatible cleaner.
5.	Supply paint, test spray and adjust fluid output, air volume and pattern width.

### 3.1 AIR HOSE AND FLUID HOSE CONNECTING EXAMPLE

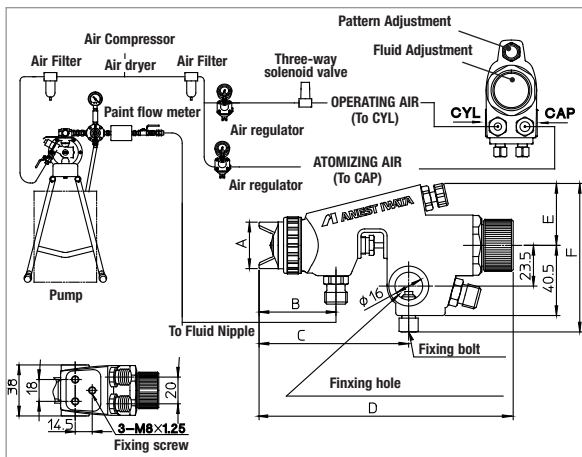

Dimensions	MODELS	A	B	C	D	E	F
	WA-200	30.5	47.5	89	148.5	36	86
WA-200 WB	30.5	47.5	89	148.5	36	86	
WA-101	27	44.5	85.5	147	36	86	
WA-101R	27	37.5	79	140.5	35	85	
LPA-200	30.5	47.5	89	148.5	36	86	

### 3.2 REPLACEMENT OF OPTIONAL HALF UNIONS

Remove air nipples, for atomizing air and operating air from gun body. Replace air nipple for atomizing air (CAP marked side) with half union for OD  $\varnothing$  8 mm air hose and air nipple for operating air (CYL marked side) with half union for OD  $\varnothing$  6 mm air hose supplied with the automatic spray gun.

**BE SURE TO CONNECT HALF UNIONS TO GUN BODY TIGHTLY.**

**NOTE:** Using air hose 12 m (39.4 ft) long, the inner diameter must be a minimum 8 mm (0.315), so the gun can have the correct air volume to atomize at 0.7 bar (10 PSI) inside air cap.

## 4. HOW TO OPERATE

- Adjust operating air pressure (CYL) from 3 to 4 bar (43 to 57 PSI).

**NOTE:** Valve orifice inside three-way solenoid valve should be minimum  $\varnothing$  4 mm (0.157 in) and also operating air hose length should be within 10 m (32.8 ft) with the inner diameter more than  $\varnothing$  6 mm (0.236 in) to avoid delayed operation and any kind of failure.

- Although atomizing air pressure varies according to spray conditions, pull the piston of the gun with the pattern adj. set fully opened and adjust as specified in above specifications table. Only in the case of the LPA 200 that is an HVLP spray gun, it will be necessary to follow the indication of air inlet pressure to obtain an atomization pressure within 0.7 (10 PSI) bar inside the air cap.
- Recommended paint viscosity differs according to paint property and painting conditions. 15 to 23 sec/Ford cup#4. is recommendable.
- Set the spray distance from the automatic spray gun to the workpiece, as near as possible within the range of: **WA-101 and WA-101R: 150~200 mm (5.9~7.9 in); WA-200 Series: 200~250 mm (7.9~9.8 in).** In the case of **LPA-200 HVLP: 100~200 mm (3.9~7.9 in).** As the LPA-200 HVLP is an automatic gun at low pressure, if the distance between the gun and the workpiece will be too far, the correct transfer efficiency will not be achieved.

## 5. MAINTENANCE & INSPECTION

	Before carrying out maintenance and inspection ALWAYS observe SAFETY WARNING indications.
Never use spare parts that are not ANEST IWATA originals.	
Never damage fluid nozzle tip, fluid needle or air cap holes.	
Never immerse the spray gun completely in liquids such as thinner.	
Never soak air cap in cleaning liquid for extended period even if cleaning.	
Never use metal objects to clean the gun.	

### 5.1 CLEANING PROCEDURE

	The fluid passages of the gun, must be cleaned thoroughly after each use, especially after use with bi-component paints. Incomplete cleaning can cause defective pattern shape.
Clean fluid passages and air cap set (1). Spray a small amount of cleaner to clean fluid passages. Incomplete cleaning can fail pattern shape and uniform particles.	
Clean each section with brush soaked with cleaner and wipe out with waste cloth. Do not immerse the whole gun in the cleaner. If done, it can damage parts. When cleaning, never scratch any holes of air cap set, fluid nozzle, or fluid needle set.	

### 5.2 DISASSEMBLING AND ASSEMBLING

BEFORE DISASSEMBLY, CLEAN FLUID PASSAGES	
1.	Remove the air cap set (1), with the fluid adjustment set fully opened, unscrew the hexagon nut of the adjustment and remove the fluid adjustment set (9), the piston spring (8) and needle spring (7), then extract the needle set (2-2) in a straight line from the gun body, in order to protect the needle packing set (11). During this operation, pay attention that the fluid adjustment set (9) does not fly out suddenly since it is strongly pushed by the needle spring (7) and piston spring (8).
2.	After removing the needle set (2-2), unscrew the fluid nozzle (2-1) and remove it from its seat, remove the protection cover (12) of the needle packing, unscrew the hexagon nut of needle packing (11) and take it out from gun body.
3.	To remove the piston set (6-2), screw the rear section of fluid needle set (2-2) into piston and pull it out from the gun body. Only in the case of <b>WA-200 ZP</b> , use the extraction bolt (17) to pull out the piston from gun body. During this operation be careful to not damage the piston packing (6-1) and the O'ring. <b>IMPORTANT: During the reassembling of the piston (6-2), apply the grease to the piston packing (6-1) and to the O'ring (5-3), to avoid any impediments to the movement of the piston.</b>
<b>IMPORTANT: TO REASSEMBLE REVERSE THE PROCEDURE, FOLLOWING THE POINTS IN DECREASING ORDER (3-2 and 1).</b>	





### 5.3 IMPORTANT RECOMMENDATIONS

	Fluid needle packing set (11), must always be adjusted while fluid needle set (2-2) is inserted and in the following way: tighten it by hand (about a 60 degrees turn) and then with spanner. When you remove needle packing set (11), do not leave the plastic piece of needle packing set in the gun body.
<b>IMPORTANT:</b> If you tighten fluid needle packing set (11) too much, fluid needle set (2-2) will not move smoothly, resulting in paint leakage from tip of fluid nozzle (2-1). Try to adjust it carefully while pulling trigger and confirming movement of fluid needle set (2-2) If you tighten it too much, repeat operation.	
When replacing fluid nozzle set (2-1) and fluid needle set (2-2), check the correct coupling of both, in order to avoid any paint leakage from the fluid nozzle during spray gun operation.	
When closing the fluid adjustment set (9) and the fluid nozzle (2-1), always make sure that the fluid adjustment knob is completely loosened.	

### 5.4 INSPECTION & REPLACEMENT STANDARD

WHERE TO INSPECT	REPLACEMENT PART
Each hole passage of air cap (1) and fluid nozzle (2-1).	Replace if it is crushed or deformed.
Packing and O ring.	Replace if it is deformed or worn out.
Leakage from seat section between fluid nozzle (2-1) and fluid needle set (2-2).	Replace them if leakage does not stop after fully cleaning fluid nozzle (2-1) and fluid needle set (2-2). If you replace fluid nozzle (2-1) or fluid needle set (2-2) only, fully match them and confirm that there is no leakage.

## 6. TROUBLESHOOTING

PROBLEM	REMEDY	
<b>GUN DOES NOT SPRAY</b>		
	Fluid adj. knob (9) closed.	Check and adjust it.
	Tip hole of nozzle (2-1) obstructed.	Check and clean it.
	Deposit of paint between the fluid needle (2-2) and the needle packing set (11).	Check and clean it.
<b>INTERMITTENT SPRAY PATTERN</b>		
	Air escapes from fluid nozzle (2-1) and the conical seats of the gun body.	Check , clean or replace.
	Air escapes from fluid needle packing (11).	Tighten.
	Air escapes from fluid hose joint.	Tighten.
	Dirty inside air cap set (1).	Clean.
<b>DEFECTIVE SPRAY PATTERN</b>		
	Dirty nozzle (2-1) or air cap set (1).	Clean carefully.
	Nozzle (2-1) or air cap (1) has been damaged.	Replace if damaged.
	Fluid nozzle (2-1) is loose.	Tighten.
	Paint viscosity too high or too low.	Dilute paint or increase viscosity.
	Fluid output too high or too low.	Adjust fluid adj. knob (9) to reduce or increase.
<b>LEAKING</b>		
	Fluid nozzle (2-1), needle set (2-2) or gun body, dirty, damaged or worn on seat.	Check , clean or replace.
	Loose fluid adj. knob (9).	Adjust.
	Fluid needle spring set (7) is worn.	Replace.
	Loose fluid nozzle set (2-1).	Tighten.
	Needle packing set (11) loose, too tight, dirty or worn.	Adjust, clean or replace.
	Piston set (6-2) dirty, damaged, worn on seat.	Clean or replace.
	Piston spring (8) is worn.	Replace.
Piston packing (6-1) is worn.	Replace.	

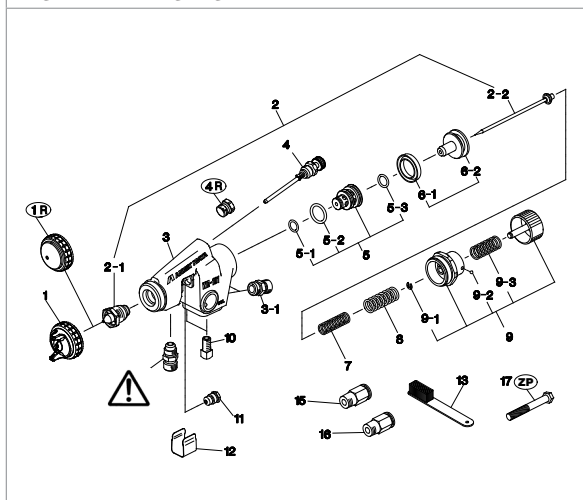
**7. SPARE PARTS LIST**

POS.	DESCRIPTION	
1	AIR CAP SET	
1R	AIR CAP SET (WA-101 R)	
2-1	FLUID NOZZLE SET	•
2-2	FLUID NEEDLE SET	•
3	BODY SET	
3-1	AIR NIPPLE	
4	PATTERN ADJUSTMENT	
4R	PLUG (WA-101 R)	
5	AIR VALVE SEAT	
5-1	O RING	•
5-2		
5-3		
6-1	PISTON PACKING	•
6-2	PISTON	
7	NEEDLE SPRING	
8	PISTON SPRING	
9	FLUID ADJUSTMENT SET	
9-1	STOP RING	
9-2	BALL	
9-3	FLUID ADJUSTMENT SPRING	
10	FIXING BOLT	
11	NEEDLE PACKING SET	•
12	PROTECTION COVER	
13	BRUSH	
15	HALF UNION FOR Ø 6 (CYL)	
16	HALF UNION FOR Ø 8 (CAP)	
17	BOLT (WA-200 ZP)	
•	<b>Marked parts are wearable parts</b>	

**NOZZLE\_NEEDLE SET COMBINATION**

MODELS	Fluid Nozzle set		Needle set
	Size ø mm	Mark	Mark
<b>WA-101</b>			
WA-101	0.8 (0.031)	W101/08	WA12
WA-101	1.0 (0.039)	W101/10	
WA-101 R	0.5 (0.020)	W101/05	WA05
<b>WA-200</b>			
WA-200	0.8 (0.031)	W200/08	WA12
WA-200	1.0 (0.039)	W200/10	
WA-200	1.2 (0.047)	W200/12	
WA-200	1.5 (0.059)	W200/15	WA15
WA-200	2.0 (0.079)	W200/20	WA20
WA-200	2.5 (0.098)	W200/25	WA25
<b>WA-200 WB</b>			
WA-200 WB	0.8 (0.031)	200WB/08	WA12
WA-200 WB	1.0 (0.039)	200WB/10	
WA-200 WB	1.2 (0.047)	200WB/12	
WA-200 WB	1.4 (0.055)	200WBS1/14	WA15
WA-200 WB	1.6 (0.063)	200WB/16	
<b>WA-200 ZP</b>			
WA-200 ZP	1.5 (0.059)	W200/15Z	-----
WA-200 ZP	2.0 (0.079)	W200/20Z	
WA-200 ZP	2.5 (0.098)	W200/25Z	
<b>LPA-200</b>			
LPA-200	1.8 (0.071)	L200/12	WA12





**NEVER REMOVE FLUID NIPPLE FROM GUN BODY!** Any malfunctions resulting by the removal of this parts will not be covered by the Warranty. In case of replacement contact your Technical Service directly.



When ordering parts, specify gun model, part name with No. and marked No. of air cap set, fluid nozzle and fluid needle.







	Prima di procedere all'installazione, alla messa in funzione, alla regolazione o alle operazioni di manutenzione, leggere attentamente il presente manuale d'istruzione, che deve essere conservato per ogni futuro riferimento.
  II 2G X	La pistola automatica <b>ANEST IWATA</b> per verniciatura è in conformità alla normativa <b>ATEX 2014/34/EU</b> .
Livello di protezione: categoria II 2G X adatto per uso in Zone 1 e 2. Marchiatura X: L'elettricità statica deve essere scaricata dalla pistola e condotta a terra attraverso la tubazione conduttiva dell'aria come previsto.	

	<b>Assicurarsi di rispettare SEMPRE, le avvertenze per la sicurezza, contenute nel suddetto manuale d'istruzione.</b>		
Simbolo	SIGNIFICATO	LIVELLO DI PERICOLO	CONSEGUENZE
	<b>AVVERTENZE</b>	SITUAZIONE POTENZIALMENTE PERICOLOSA	Seri rischi per la salute e la vita dell'operatore
	<b>ATTENZIONE</b>		Rischi moderati per il prodotto e l'operatore
	<b>IMPORTANTE</b>		Danni materiali

## 1. SPECIFICHE TECNICHE

MODELLI	WA-200	WA-200 WB	WA-200 ZP	WA-101	WA-101 R	LPA-200
Max. pressione d'esercizio aria:	7.0 bar (100 PSI)					
Livello rumorosità (LAeqT)*	81.2 dB(A)	76.8 dB(A)	79.0 dB(A)	78.7 dB(A)	62.8 dB(A)	76.9 dB(A)
Raccordo aria:	G1/4"					
Raccordo materiale:	G1/4"	G1/4"	G3/8"	G1/4"	G1/4"	G3/8"
Max. Temperatura:	Ambiente 5 ~ 40 °C - Aria/Fluidi 5 ~ 43 °C					
*Punto di misurazione: 1 m dietro la pistola, 1,6 m d'altezza.						

### 1.1 DATI TECNICI

MODELLI									
<b>WA-200 WB</b>									
WA-200 WB-081P	0.8	WB1	1.6	200	340	360	470		
WA-200 WB-101P	1.0			250					
WA-200 WB-121P	1.2			300				380	
WA-200 WB-141P	1.4								
WA-200 WB-161P	1.6								
<b>WA-200</b>									
WA-200-062	0.6	LV2	2.0	255	270	280	500		
WA-200-084	0.8								
WA-200-104	1.0								
WA-200-124	1.2								
WA-200-154	1.5								
WA-200-082P	0.8	G2P	3.0	500	530	400			
WA-200-102P	1.0								
WA-200-122P	1.2								
WA-200-152P	1.5	K2	3.0	270	330	340			
WA-200-202P	2.0	R2							
WA-200-251P	2.5	W1							
<b>WA-200 FLAT AND THIN® (Ventaglio Piatto)</b>									
WA-200-066P FT	0.6	FT6	1.8	80	170	140	550		
WA-200-086P FT	0.8			100				185	150
WA-200-106P FT	1.0			120				200	160
WA-200-126P FT	1.2			140				220	180
<b>WA-200 ZP (per Vernici Abrasive)</b>									
WA-200-151ZP	1.5	R1Z	3.5	760	500	370	470		
WA-200-201ZP	2.0								
WA-200-251ZP	2.5								
<b>WA-101</b>									
WA-101-082P	0.8	E2P	3.0	150	270	190	460		
WA-101-102P	1.0	E2P							
WA-101-101P	1.0	E1							
WA-101-132P	1.3	H2							
<b>WA-101 R (con Ventaglio Conico)</b>									
WA-101R-05P	0.5	RP	3.0	20	40	35	440		
<b>LPA-200 HVLP</b>									
LPA-200-122P	1.2	G2	2.0	500	500	300	500		
LPA-200-S5-12P	1.2	G2	2.0	250	560	250			



## 2. AVVERTENZE DI SICUREZZA

<b>RISCHI DI INCENDI ED ESPLOSIONI</b>	
Mai utilizzare <b>SOLVENTI IDROCARBURI ALOGENATI</b> , che potrebbero causare danni e scioglimento delle parti in alluminio del corpo pistola, provocati da reazioni chimiche. <b>SOLVENTI INCOMPATIBILI</b> : cloruro di metile, diclorometano, 1.2-dicloroetano, tetracloruro di carbonio, tricloroetilene, 1.1.1-tricloroetano.	  
La presenza di fiamme libere e la produzione di scintille è severamente vietata. I prodotti utilizzati possano essere altamente infiammabili e quindi causa di gravi incendi. Evitare ogni azione che potrebbe provocare incendi, come fumare, provocare scintille o qualsiasi rischio elettrico.	
Collegare correttamente a terra la pistola per verniciatura, utilizzando un tubo aria conduttivo. (<1MΩ). Controllare periodicamente la stabilità della messa terra.	
<b>RISCHI PER LA SALUTE</b>	
Usare la pistola per verniciatura in ambienti, ben ventilati utilizzando la cabina di verniciatura. Una ventilazione inadeguata o insufficiente potrebbe provocare un'intossicazione da solventi organici o causare incendi.	  
Indossare sempre indumenti protettivi (occhiali di protezione, maschera, guanti). Per evitare che il contatto con i materiali irritanti, provochi infiammazione agli occhi ed alla pelle. Nel caso in cui si verificasse anche il più lieve rischio di danno fisico, consultare immediatamente un medico.	
Se è necessario indossare i tappi fonizzanti. Il livello di rumorosità può superare 80 dB(A) e dipende dalle condizioni d'utilizzo e dall'area di lavoro.	
<b>RISCHI DI USO IMPROPRIO</b>	
MAI puntare la pistola in direzione del corpo umano o di animali.	
MAI superare la pressione o la temperatura massima d'esercizio.	
<b>SCARICARE SEMPRE la pressione dell'aria e del materiale, prima delle operazioni di pulizia, disassemblaggio e di manutenzione.</b> Altrimenti la pressione residua potrebbe causare ferite al corpo provocate da operazioni scorrette o dall'emissione dei liquidi usati per la pulizia. Per scaricare la pressione, chiudere l'alimentazione dell'aria compressa e della vernice. Quindi fornire solo l'aria al pistone e scaricare il materiale operando sull'astina. Questa azione provocherà l'arresto automatico dell'aria compressa.	
L'estremità dell'astina è tagliente. Per non rischiare di ferirsi, evitare di toccare l'estremità dell'astina durante le operazioni di manutenzione.	
Mai spruzzare prodotti alimentari o chimici con questa pistola. Altrimenti la miscela di sostanze estranee potrebbe causare la corrosione dei passaggi vernice, con conseguenti danneggiamenti alla pistola e rischi per la salute.	
Mai modificare la pistola per verniciatura, per evitare danneggiamenti che potrebbero compromettere la qualità del risultato.	
Nel caso di malfunzionamenti, sospendete immediatamente le operazioni di verniciatura per la ricerca del guasto. Non utilizzare nuovamente il prodotto finché non si è risolto il problema.	
Mai entrare nelle aree di lavoro delle attrezzature (come: robot, reciprocatori, ecc.), finché queste non siano state disattivate. Altrimenti, il contatto con i macchinari in funzione potrebbe essere causa di incidenti e ferimenti.	

## 3. COLLEGAMENTO

	Per alimentare la pistola utilizzare aria filtrata ed asciutta. L'utilizzo di aria non filtrata potrebbe provocare difetti di verniciatura.
Quando si utilizza la pistola per la prima volta dopo l'acquisto, pulire i passaggi vernice spruzzando detergente compatibile per rimuovere l'olio antiruggine. Altrimenti l'olio residuo potrebbe causare malfunzionamenti della pistola con conseguenti difetti di verniciatura.	
Utilizzare una valvola solenoide a tre vie il cui diametro della sezione interna dovrà essere maggiore di 4 mm ed una tubazione aria con un diametro interno maggiore di 6 mm e con lunghezza non superiore a 10 m. Altrimenti, una valvola solenoide con un diametro troppo piccolo ed una tubazione aria di lunghezza eccessiva tra la valvola e la pistola, potrebbero causare ritardi nelle operazioni.	
Collegare saldamente la tubazione alla pistola, per evitare che lo scollegamento della tubazione o le perdite durante le operazioni di verniciatura provochino ferite gravi al corpo.	

1. Montare la pistola sulla staffa di fissaggio, direzionare il getto di verniciatura e fissare la pistola nella posizione corretta, tramite il bullone di fissaggio.
2. Collegare saldamente la tubazione dell'aria d'atomizzazione al lato aria siglato CAP e la tubazione dell'aria di funzionamento al lato aria siglato CYL.
3. Collegare saldamente la tubazione della vernice al raccordo del materiale della pistola.
4. Alimentare la pistola automatica con detergente compatibile e spruzzare per detergere i passaggi della vernice.
5. Alimentare la pistola automatica con la vernice, verificare lo spruzzo e regolare il volume dell'aria, la portata del materiale ed il ventaglio secondo le vostre necessità.

### 3.1 COLLEGAMENTO DELLA TUBAZIONE ARIA E VERNICE

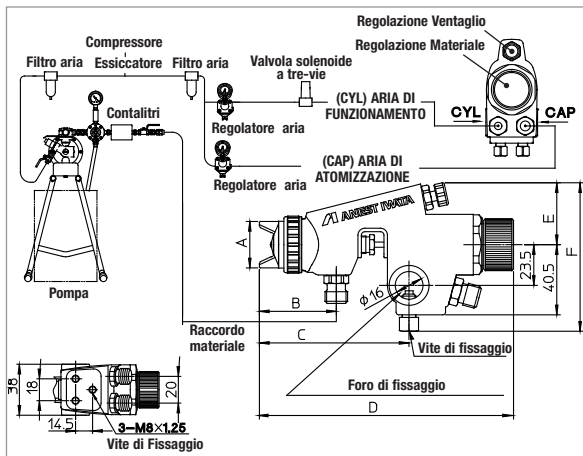

Dimensioni	MODELLI	A	B	C	D	E	F
	<b>WA-200</b>	30.5	47.5	89	148.5	36	86
<b>WA-200 WB</b>	30.5	47.5	89	148.5	36	86	
<b>WA-101</b>	27	44.5	85.5	147	36	86	
<b>WA-101R</b>	27	37.5	79	140.5	35	85	
<b>LPA-200</b>	30.5	47.5	89	148.5	36	86	

### 3.2 SOSTITUZIONE DEI RACCORDI RAPIDI OPZIONALI

Rimuovere dal corpo pistola, il raccordo aria per l'atomizzazione ed il raccordo aria per il funzionamento. Sostituire il raccordo aria per l'atomizzazione (siglato CAP) con il raccordo rapido per tubazioni da  $\varnothing$  8 mm (dia. esterno) ed il raccordo aria di funzionamento (siglato CYL) con il raccordo rapido per tubazioni da  $\varnothing$  6 mm (dia. esterno).

**ASSICURARSI SEMPRE** di fissare saldamente gli attacchi rapidi al corpo della pistola.

**IMPORTANTE:** Quando si utilizza una tubazione aria lunga 12 m (39.4 ft), il suo diametro interno deve essere di almeno 8 mm (0.315), in maniera tale di atomizzare a 7.0 bar (10 PSI) nell'ugello aria.

## 4. COME OPERARE

1. Regolare la pressione aria di funzionamento (CYL) ad un valore compreso tra 3 e 4 bar. (43 a 57 PSI).

**NOTA:** Il diametro interno della valvola solenoide a tre vie dovrebbe misurare minimo  $\varnothing$  4 mm (0.157 in) e la lunghezza del tubo aria non dovrebbe essere maggiore di 10 m (32.8 ft) ed avere un diametro interno maggiore di  $\varnothing$  6 mm (0.236 in) per evitare ritardi durante le operazioni e difetti nelle applicazioni.

2. La pressione d'atomizzazione aria varia a seconda delle applicazioni. Per regolarla è necessario tenere premuto il pistone con la regolazione ventaglio completamente aperta e registrarla secondo le indicazioni contenute nella tabella delle specifiche tecniche.

2.	Solo nel caso della pistola LPA 200 essendo una pistola HVLP, sarà necessario seguire l'indicazione della pressione dell'aria in entrata per ottenere una pressione di atomizzazione di 0,7 (10 PSI) bar interna all'ugello aria.
3.	La corretta viscosità del materiale, benché dipenda dalle proprietà della vernice stessa e dalle condizioni di verniciatura; è consigliata tra 15 e 23 secondi Coppa Ford #4.
4.	Nel caso delle pistole <b>WA-101</b> e <b>WA-101R</b> calibrare la distanza di spruzzo fra la pistola ed il pezzo di lavorazione il più vicino possibile e ad una distanza compresa fra 150~200 mm (5.9~7.9 in) nel caso delle pistole della serie <b>WA-200</b> fra 200~250 mm (7.9 a 9.8 in), mentre nel caso della <b>LPA-200</b> fra 100~200 mm (3.9~7.9 in). Siccome la pistola LPA 200 HVLP funziona a bassa pressione, se lo spazio fra la pistola ed il pezzo di lavorazione sarà troppo distante, non si otterrà una corretta efficienza di trasferimento.

## 5. MANUTENZIONE ED ISPEZIONE

	<b>Prima di procedere a qualsiasi operazione d'ispezione e manutenzione, leggere sempre ed osservare scrupolosamente tutte le indicazioni sulle Avvertenze di Sicurezza.</b>
<b>Mai utilizzare altri componenti o parti di ricambio che non siano originali ANEST IWATA.</b>	
<b>Mai danneggiare i fori dell'ugello aria, dell'ugello materiale e l'estremità dell'astina.</b>	
<b>Mai immergere completamente la pistola nei liquidi detergenti.</b>	
<b>Mai lasciare immerso l'ugello aria nel liquido di pulizia per un periodo prolungato, anche durante la pulizia. Mai utilizzare oggetti metallici per la pulizia della pistola.</b>	

### 5.1 PROCEDURA PER LA PULIZIA

	<b>I passaggi del materiale devono essere accuratamente puliti dopo ogni utilizzo della pistola e in particolar modo dopo l'uso di vernici bi-componenti. Una pulizia incompleta potrebbe causare difetti alla forma del ventaglio.</b>
<b>Pulire tutti i passaggi del materiale e del set ugello aria (1). Spruzzare una piccola quantità di liquido di pulizia per pulire i passaggi vernice. Una pulizia incompleta può provocare difetti alla forma del ventaglio.</b>	
<b>Pulire ogni sezione con uno spazzolino imbevuto di liquido di pulizia ed uno strofinaccio assorbente. Mai immergere completamente la pistola nel liquido di pulizia, in quanto ciò potrebbe causare danni al prodotto. Durante la pulizia, evitate di graffiare le superfici dei fori dell'ugello aria, dell'ugello materiale e l'astina.</b>	

### 5.2 DISASSEMBLAGGIO E RIASSEMBLAGGIO

<b>PULIRE SEMPRE I PASSAGGI VERNICE PRIMA DELLO SMONTAGGIO DELLA PISTOLA.</b>	
1.	Rimuovere l'ugello aria (1), con la regolazione astina completamente aperta, svitare il dado esagonale della regolazione e rimuovere il set regolazione astina (9), la molla pistone (8), la molla astina (7), quindi estrarre l'astina (2-2) in linea retta dal corpo pistola, per proteggere il set guarnizione astina (11). Durante questa fase fare attenzione che la regolazione astina (9) non venga spinta fuori bruscamente, poiché subisce una forte pressione dalla molla astina (7) e dalla molla del pistone (8).
2.	Dopo aver rimosso l'astina, svitare l'ugello materiale (2-1) ed estrarlo dalla sua sede, rimuovere la protezione (12) della guarnizione astina, svitare il dado esagonale della guarnizione astina (11) ed estrarla dal corpo pistola.
3.	Per rimuovere il pistone (6-2), avvitare la sezione posteriore dell'astina (2-2) nel pistone ed estrarlo. Solo nel caso della <b>WA-200 ZP</b> utilizzare la vite d'estrazione (17) per estrarre il pistone dal corpo pistola. Attenzione a non danneggiare la guarnizione del pistone (6-1) e l'O'ring durante la rimozione. <b>IMPORTANTE: Durante il riassetto del pistone, applicare del grasso alla guarnizione del pistone (6-1) ed all'O'ring (5-3), per evitare impedimenti al movimento del pistone stesso.</b>
<b>IMPORTANTE: PER RIMONTARE PROCEDERE IN MODO INVERSO SEGUENDO I PUNTI IN ORDINE DECRESCENTE (3-2 e 1)</b>	

### 5.3 RACCOMANDAZIONI IMPORTANTI

	<b>La regolazione del set guarnizione astina (11) deve sempre essere effettuata con l'astina (2-2) montata e nel seguente modo: chiudere manualmente e successivamente stringere con l'apposita chiave per circa 1/6 di giro (60 gradi). Quando rimuovete il set guarnizione astina (11) assicuratevi di non lasciare il pezzo di plastica della guarnizione, nel corpo pistola.</b>
<b>IMPORTANTE: Un avvitamento eccessivo del set guarnizione astina (11), può provocare un impedimento al movimento del set astina (2-2), con conseguente trafilamento di vernice dall'estremità dell'ugello materiale (2-1). Regolare lentamente, controllando il movimento del set astina (2-2). Se risultasse eccessivamente avvitato, svitatelo completamente ed avvitatelo nuovamente con cura.</b>	

Quando si sostituisce l'ugello materiale (2-1) e l'astina (2-2), verificare il corretto l'accoppiamento di entrambi per evitare eventuali trafileamenti di vernice dall'ugello materiale durante l'utilizzo della pistola.

Quando si chiudono la regolazione del materiale (9) e l'ugello materiale (2-1), assicurarsi sempre che il pomello della regolazione del materiale sia completamente allentato.

## 5.4 ISPEZIONI E SOSTITUZIONI STANDARD

PARTI DA CONTROLLARE	PARTI DA SOSTITUIRE
Ogni foro di passaggio dell'ugello aria (1) e dell'ugello materiale (2-1).	Sostituire se schiacciato o deformato.
Guarnizioni ed O'ring.	Sostituire se deformate od usurate.
Perdite dalle sezioni delle sedi tra l'ugello materiale (2-1) e l'astina (2-2).	Sostituire se le perdite non si arrestano anche dopo che il set ugello materiale (2-1) e l'astina (2-2) sono stati completamente puliti. Se sostituite solo l'ugello materiale (2-1) o l'astina (2-2), verificate il corretto accoppiamento di entrambi ed accertatevi che non vi siano eventuali perdite.

## 6. PROBLEMI, CAUSE E RIMEDI

PROBLEMI	RIMEDI	
<b>MANCATA FUORIUSCITA DI VERNICE</b>		
	Regolazione astina (9) non sufficientemente aperta.	Verificare e regolare.
	Foro ugello materiale (2-1) ostruito.	Verificare e pulire.
	Accumulo di vernice tra l'astina (2-2) ed il set guarnizione astina (11).	Verificare e pulire.
<b>ATOMIZZAZIONE AD INTERMITTENZA</b>		
	Trafilamento d'aria dall'ugello materiale (2-1) e le sedi coniche del corpo pistola.	Verificare, pulire o sostituire.
	Trafilamento aria dalla guarnizione astina (11).	Stringere.
	Trafilamento d'aria dal raccordo della tubazione del materiale.	Stringere.
	Residui di vernice nell'ugello aria (1).	Pulire.
<b>DIFETTI DEL VENTAGLIO</b>		
	Ugello materiale (2-1) o ugello aria (1) incrostati.	Pulire accuratamente.
	Ugello materiale (2-1) o ugello aria (1) danneggiati	Sostituire.
	Ugello materiale (2-1) allentato.	Stringere
	Viscosità vernice troppo elevata o troppo bassa.	Diluire la vernice o aumentare la viscosità.
Portata vernice troppo elevata o troppo bassa.	Registrare la regolazione astina (9) per ridurre o aumentare la portata.	
<b>TRAFILAMENTO DELLA VERNICE</b>		
	Ugello materiale (2-1), set astina (2-2) o corpo pistola, incrostati, danneggiati o usurati nelle sedi.	Verificare, pulire o sostituire.
	Dado regolazione astina (9) allentato.	Regolare.
	Molla astina (7) usurata.	Sostituire.
	Ugello materiale (2-1) allentato.	Stringere.
	Set guarnizione astina (11) allentata, troppo stretta, sporca o usurata.	Regolare, pulire o sostituire.
	La superficie della sede del pistone (6-2) è sporca, danneggiata o usurata.	Pulire o sostituire.
	La molla del pistone (8) è usurata.	Sostituire.
La guarnizione del pistone (6-1) è usurata.	Sostituire.	

## 7. ELENCO PARTI DI RICAMBIO

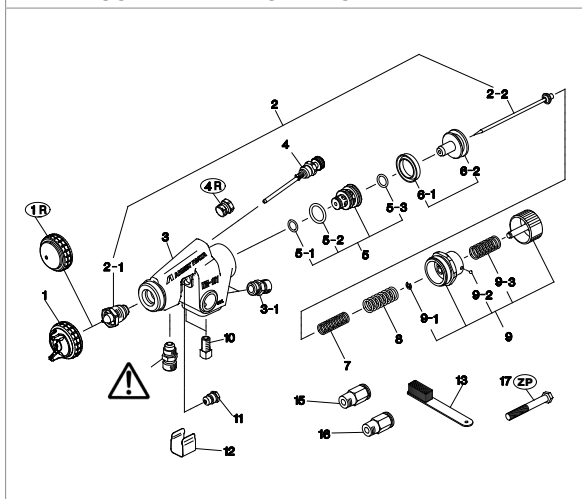

POS.	DESCRIZIONE	
1	SET UGELLO ARIA	
1R	SET UGELLO ARIA (WA-101 R)	
2-1	SET UGELLO MATERIALE	•
2-2	SET ASTINA	•
3	CORPO PISTOLA	
3-1	RACCORDO ARIA	
4	REGOLAZIONE VENTAGLIO	
4R	TAPPO A VITE (WA-101 R)	
5	SEDE VALVOLA ARIA	
5-1		
5-2	O RING	•
5-3		
6-1	GUARNIZIONE PISTONE	•
6-2	PISTONE	
7	MOLLA ASTINA	
8	MOLLA PISTONE	
9	SET REGOLAZIONE MATERIALE	
9-1	ANELLO DI FERMO	
9-2	SFERA	
9-3	MOLLA REGOLAZIONE MATERIALE	
10	DADO DI FISSAGGIO	
11	SET GUARNIZIONE ASTINA	•
12	PROTEZIONE	
13	SPAZZOLINO	
15	RACCORDO RAPIDO Ø 6 (CYL)	
16	RACCORDO RAPIDO Ø 8 (CAP)	
17	VITE DI ESTRAZIONE PISTONE	
•	Le parti contrassegnate sono soggette ad usura.	

### COMBINAZIONI SET UGELLO MATERIALE ED ASTINA





MODELLO	Set Ugello Materiale		Set Astina
	Misura ø mm	Tipo	Tipo
<b>WA-101</b>			
WA-101	0.8 (0.031)	W101/08	WA12
WA-101	1.0 (0.039)	W101/10	
WA-101 R	0.5 (0.020)	W101/05	WA05
<b>WA-200</b>			
WA-200	0.8 (0.031)	W200/08	WA12
WA-200	1.0 (0.039)	W200/10	
WA-200	1.2 (0.047)	W200/12	
WA-200	1.5 (0.059)	W200/15	WA15
WA-200	2.0 (0.079)	W200/20	WA20
WA-200	2.5 (0.098)	W200/25	WA25
<b>WA-200 WB</b>			
WA-200 WB	0.8 (0.031)	200WB/08	WA12
WA-200 WB	1.0 (0.039)	200WB/10	
WA-200 WB	1.2 (0.047)	200WB/12	
WA-200 WB	1.4 (0.055)	200WBS1/14	WA15
WA-200 WB	1.6 (0.063)	200WB/16	
<b>WA-200 ZP</b>			
WA-200 ZP	1.5 (0.059)	W200/15Z	----
WA-200 ZP	2.0 (0.079)	W200/20Z	
WA-200 ZP	2.5 (0.098)	W200/25Z	
<b>LPA-200</b>			
LPA-200	1.8 (0.071)	L200/12	WA12



**MAI RIMUOVERE IL RACCORDO MATERIALE DAL CORPO PISTOLA!** Gli eventuali malfunzionamenti derivanti dalla rimozione della suddetta parte, non saranno coperti dalla Garanzia. In caso di sostituzione rivolgersi direttamente al Servizio Tecnico di Assistenza.









In fase d'ordine si prega sempre di specificare, il modello della pistola, il nome del ricambio con il riferimento numerico, la sigla dell'ugello aria, dell'ugello materiale e dell'astina.

	Avant toute utilisation, tout réglage ou toute opération d'entretien, lire attentivement ce manuel d'instruction. Conserver ce manuel en lieu sûr pour pouvoir le consulter ultérieurement.		
  II 2G X	Le pistolet automatique ANEST IWATA est conforme aux normes ATEX 2014/34/EU.		
Niveau de protection: II 2G X adapté aux zones 1 et 2.			
Marquage X: Toute décharge d'électricité statique provenant du pistolet doit être conduite à la terre à travers le tuyau d'air conducteur comme indiqué.			
	Respecter <b>TOUJOURS</b> les avertissements pour la sécurité présents dans ce manuel d'instructions.		
Symbole	SIGNIFICATION	Niveau de danger	Conséquences
	AVERTISSEMENTS	SITUATION POTENTIELLEMENT DANGEREUSE	Risques sérieux pour la santé et la vie de l'opérateur.
	ATTENTION		Risques modérés pour le produit et l'opérateur.
	IMPORTANT		Dommmages matériels.

## 1. SPÉCIFICATIONS TECHNIQUES

MODÈLE	WA-200	WA-200 WB	WA-200 ZP	WA-101	WA-101 R	LPA-200
Pression d'air maxi d'emploi:	7.0 bar (100 PSI)					
Bruit (LAeqT)*:	81.2 dB(A)	76.8 dB(A)	79.0 dB(A)	78.7 dB(A)	62.8 dB(A)	76.9 dB(A)
Raccordement d'air:	G1/4"					
Raccordement produit:	G1/4"	G1/4"	G3/8"	G1/4"	G1/4"	G3/8"
Température Maxi:	Milieu 5 ~ 40 °C - Air/Produit 5 ~ 43 °C					
*Emplacement de mesure: 1 m derrière le pistolet, 1.6 m de hauteur						

### 1.1 DONNÉES TECHNIQUES

MODÈLES							
	Ø mm	No.	bar	m <sup>3</sup> /min	N <sup>2</sup> /min	mm	g
<b>WA-200 WB</b>							
WA-200 WB-081P	0.8	WB1	1.6	200	340	360	470
WA-200 WB-101P	1.0			250			
WA-200 WB-121P	1.2			300			
WA-200 WB-141P	1.4						
WA-200 WB-161P	1.6						
<b>WA-200</b>							
WA-200-062	0.6	LV2	2.0	255	270	280	500
WA-200-084	0.8						
WA-200-104	1.0						
WA-200-124	1.2						
WA-200-154	1.5						
WA-200-082P	0.8	G2P	3.0	500	530	400	
WA-200-102P	1.0						
WA-200-122P	1.2	K2	3.0	270	330	340	
WA-200-152P	1.5						
WA-200-202P	2.0	R2	3.0	400	360	320	
WA-200-251P	2.5	W1					500
<b>WA-200 FLAT AND THIN® (avec Jet Plat)</b>							
WA-200-066P FT	0.6	FT6	1.8	80	170	140	550
WA-200-086P FT	0.8			100	185	150	
WA-200-106P FT	1.0			120	200	160	
WA-200-126P FT	1.2			140	220	180	
<b>WA-200 ZP (pour Peinture Abrasive)</b>							
WA-200-151ZP	1.5	R1Z	3.5	760	500	370	470
WA-200-201ZP	2.0						
WA-200-251ZP	2.5						
<b>WA-101</b>							
WA-101-082P	0.8	E2P	3.0	150	270	190	460
WA-101-102P	1.0	E2P		200	270	220	
WA-101-101P	1.0	E1		100	90	140	
WA-101-132P	1.3	H2		250	260	230	
<b>WA-101 R (avec Jet Rond)</b>							
WA-101R-05P	0.5	RP	3.0	20	40	35	440
<b>LPA-200 HVLP</b>							
LPA-200-122P	1.2	G2	2.0	500	500	300	500
LPA-200-S5-12P	1.2	G2	2.0	250	560	250	

## 2. AVERTISSEMENT DE SÉCURITÉ

<b>INCENDIES ET EXPLOSIONS</b>	
<p><b>Ne jamais utiliser les SOLVANTS HYDROCARBONÉS HALOGENÉS</b>, reportés ci-dessous; car ils risquent de provoquer des fissures ou la dissolution du corps du pistolet (aluminium) en conséquence de la réaction chimique. <b>SOLVANTS INADEQUATS:</b> chlorure de méthyle, dichloro-méthane, 1,2-dichlororo-éthane, tétrachlorure de carbone, trichloroéthylène, 1,1,1-trichloro-éthane.</p>	
<p><b>Les étincelles et les flammes nues sont strictement interdites.</b> Les produits sont facilement inflammables et susceptibles de causer un incendie. Ne pas les exposer aux flammes nues, à l'électroménager, aux cigarettes etc.</p>	
<p><b>Relier le pistolet à la terre en utilisant le tuyau d'air conducteur. (&lt;1MΩ)</b> S'assurer toujours que le pistolet soit correctement relié à la terre.</p>	
<b>PROTECTION CORPORELLE</b>	
<p><b>Utiliser le pistolet dans un lieu bien ventilé avec une cabine de pulvérisation.</b> Une ventilation insuffisante peut provoquer une intoxication par les solvants organiques ou un incendie.</p>	
<p><b>Porter toujours des protections personnelles (lunettes, masques et gants de sécurité)</b> afin d'éviter des inflammations des yeux et de la peau causées par le liquide de nettoyage etc. En cas de problèmes, consulter un médecin.</p>	
<p><b>Porter des bouche-oreilles le cas échéant.</b> Le niveau de bruit peut dépasser 80 dB(A) en fonction des conditions et du lieu d'emploi.</p>	
<b>EMPLOI ABUSIF</b>	
<p><b>Ne jamais diriger le pistolet sur des personnes ou des animaux.</b></p>	
<p><b>Ne jamais dépasser la pression ou la température maximale d'emploi.</b></p>	
<p><b>Décharger toujours la pression d'air et du produit avant de procéder au nettoyage, au démontage ou à l'entretien du pistolet.</b> Dans le cas contraire, la pression résiduelle risque de provoquer des lésions corporelles dues à l'emploi abusif ou à la dispersion du liquide de nettoyage. Pour décharger la pression, fermer l'alimentation de l'air comprimé et du produit. Ensuite, fournir l'air seulement au piston et décharger le matériel en agissant sur l'aiguille. Cette action provoquera l'arrêt automatique de l'air comprimé.</p>	
<p><b>L'extrémité de l'aiguille a un côté coupant.</b> Ne pas toucher l'extrémité de l'aiguille pour éviter de vous blesser.</p>	
<p><b>Ne jamais pulvériser de produits alimentaires ou chimiques avec ce pistolet;</b> cela peut causer des accidents liés à la corrosion des conduits du produit ou des dommages à la santé dus au mélange avec des matériaux étrangers.</p>	
<p><b>Ne jamais modifier le pistolet pour pulvérisation</b> pour éviter tout endommagement susceptible de compromettre la qualité du résultat.</p>	
<p><b>En cas de mauvais fonctionnement, interrompre immédiatement les opérations de pulvérisation pour la recherche de la panne. Ne pas réutiliser le produit tant que le problème n'a pas été résolu.</b></p>	
<p><b>Ne jamais entrer dans les zones de mouvements des équipements (tels que robots, réciprocaturs, etc.), tant que ces derniers n'ont pas été désactivés.</b> Dans le cas contraire, le contact avec les machines en marche pourrait entraîner des accidents et des blessures.</p>	

## 3. CONNEXION

	<p><b>Pour alimenter le pistolet utiliser de l'air filtré et sec.</b> L'utilisation d'air non filtré peut entraîner des défauts de peinture.</p>
<p><b>Lorsqu'on utilise le pistolet pour la première fois, nettoyer les passages du produit en pulvérisant de liquide de nettoyage compatible pour éliminer l'huile antirouille.</b> Sinon, l'huile résiduelle pourrait provoquer un dysfonctionnement du pistolet et entraîner des défauts de peinture.</p>	
<p><b>Utiliser une vanne à solénoïde à trois voies dont le diamètre de la section intérieure devra être supérieur à 4 mm et un tuyau d'air ayant un diamètre intérieur supérieur à 6 mm et une longueur non supérieure à 10 m.</b> Dans le cas contraire, une vanne à solénoïde avec un diamètre trop petit et un tuyau d'air avec une longueur excessive entre la vanne et le pistolet, pourraient causer des retards pendant les opérations.</p>	
<p><b>Raccorder solidement le tuyau au pistolet pour éviter que le débranchement du tuyau ou les pertes pendant les opérations de pulvérisation ne provoquent de blessures graves au corps.</b></p>	

1. Fixer le pistolet à l'étrier de fixation, diriger le jet de pulvérisation et bloquer le pistolet dans la position correcte au moyen du boulon de fixation.
2. Raccorder fermement le tuyau de l'air d'atomisation au côté d'air marqué CAP et le tuyau de l'air de fonctionnement au côté d'air marqué CYL.
3. Raccorder solidement le tuyau peinture au raccord produit du pistolet.
4. Alimenter le pistolet automatique avec du détergent et pulvériser pour nettoyer les passages du produit.
5. Alimenter le pistolet automatique avec la peinture, vérifier la pulvérisation et régler le volume de l'air, le débit du produit et le jet selon vos nécessités.

### 3.1 CONNEXION DU TUYAU D'AIR ET DE TUYAU PEINTURE

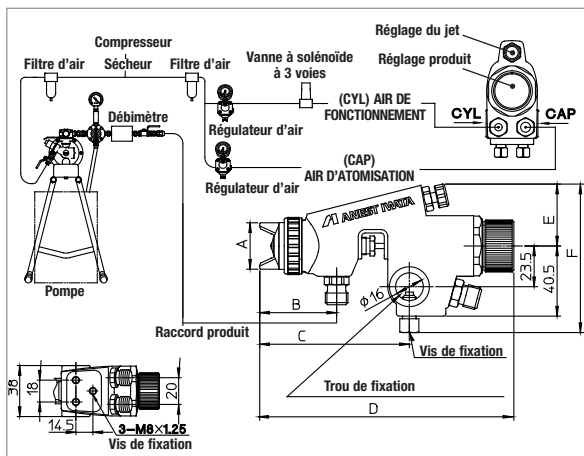

Dimensions	MODÈLES	A	B	C	D	E	F
	WA-200	30.5	47.5	89	148.5	36	86
WA-200 WB	30.5	47.5	89	148.5	36	86	
WA-101	27	44.5	85.5	147	36	86	
WA-101R	27	37.5	79	140.5	35	85	
LPA-200	30.5	47.5	89	148.5	36	86	

### 3.2 REMPLACEMENT DES RACCORDS RAPIDES OPTIONNELS

Retirer du corps du pistolet, le raccord d'air pour l'atomisation et le raccord d'air pour le fonctionnement. Remplacer le raccord d'air pour l'atomisation (marqué CAP) avec le raccord rapide pour les tuyaux  $\varnothing$  8 mm et le raccord d'air de fonctionnement (marqué CYL) avec le raccord rapide pour les tuyaux  $\varnothing$  6 mm.

**S'assurer TOUJOURS de connecter fermement les raccords rapides au corps du pistolet.**

**IMPORTANT:** Lorsque on utilise un tuyau d'air de 12 m (39,4 pieds), son diamètre interne doit être d'au moins 8 mm (0,315), afin de pulvériser à 7,0 bar (10 PSI) dans le chapeau d'air.

## 4. COMMENT PROCÉDER

1. Régler la pression de l'air de fonctionnement (CYL) entre 3 et 4 bar (43 ~ 57 PSI).

**REMARQUE:** Le diamètre interne de la vanne à solénoïde à trois voies doit mesurer au moins  $\varnothing$  4 mm (0,157 in) et la longueur du tuyau d'air ne doit pas dépasser 10 m (32,8 ft) et avoir un diamètre interne supérieur à  $\varnothing$  6 mm (0,236 in) pour éviter des retards pendant les opérations et des défauts dans les applications.

2. La pression d'air de pulvérisation change en fonction des applications. Pour la régler, tirez le piston du pistolet avec le réglage du jet complètement ouvert et enregistrer conformément aux indications du tableau des spécifications techniques. Seulement dans le cas du pistolet LPA-200, car il est un pistolet HVLP, il sera nécessaire de suivre l'indication de la pression d'air d'entrée pour obtenir une pression d'atomisation de 0,7 bar (10 PSI) à l'intérieur du chapeau d'air.



3.	La viscosité de la peinture dépend des propriétés de la peinture utilisée et des conditions de vernissage; il est recommandé entre 15 et 23 secondes Ford Cup # 4.
4.	Dans le cas des pistolets suivants, calibrer la distance de pulvérisation entre le pistolet et la pièce à travailler le plus près possible et à une distance entre: <b>WA-101 et WA-101R:</b> 150 ~ 200 mm (5.9~7.9 in)   <b>WA-200, WA-200 WB et WA-200 ZP:</b> 200~250 mm (7.9~9.8 in). Dans le cas du pistolet <b>LPA-200</b> entre 100~200 mm (3.9~7.9 in). Comme le pistolet LPA-200 HVLP fonctionne à basse pression, si la distance entre le pistolet et la pièce à travailler est trop éloignée, l'efficacité de transfert ne sera pas correcte.

## 5. ENTRETIEN ET INSPECTION

	Avant de commencer toute opération d'inspection, lire et observer scrupuleusement toutes les indications concernant les AVERTISSEMENTS DE SÉCURITÉ.
<b>NE JAMAIS</b> utiliser d'autres composants ou des pièces de rechange non originales ANEST IWATA.	
<b>NE JAMAIS</b> endommager les trous du chapeau, de la buse et de l'extrémité de l'aiguille.	
<b>NE JAMAIS</b> immerger complètement le pistolet dans des liquides tels que du solvant.	
<b>NE JAMAIS</b> laisser le chapeau (1) tremper dans le liquide de nettoyage trop longtemps, même pendant le nettoyage. <b>NE JAMAIS</b> utiliser d'objets métalliques pour le nettoyage du pistolet.	

### 5.1 PROCEDURE DE NETTOYAGE

	En particulier, nettoyer complètement et soigneusement les conduits de peinture après l'emploi avec une peinture de deux composants.
Nettoyer tous les passages du produit et du chapeau (1). Pulvériser une petite quantité de liquide de nettoyage pour nettoyer les conduits de peinture. Un nettoyage incomplet peut provoquer des défauts à la forme du jet.	
Nettoyer chaque section à l'aide d'une brosse imbibée de liquide de nettoyage et d'un chiffon absorbant. Ne jamais immerger complètement le pistolet dans le liquide de nettoyage, car cela peut endommager le produit. Pendant les opérations de nettoyage, faire attention à ne pas griffer les trous du chapeau, de la buse et de l'aiguille.	

### 5.2 PROCEDURE DE DÉMONTAGE

<b>TOUJOURS NETTOYER LES PASSAGES DE PEINTURE AVANT LE DÉMONTAGE DU PISTOLET.</b>	
1.	Enlevez le chapeau d'air (1) avec le réglage produit complètement ouvert, dévissez l'écrou hexagonal du réglage et enlevez le réglage produit (9), le ressort de piston (8), le ressort d'aiguille (7), puis extrayez l'aiguille (2-2) en ligne droite du corps du pistolet, pour protéger le joint d'aiguille (11). Pendant cette phase, veillez à ce que le réglage produit (9) ne soit pas expulsé brusquement car il est soumis à une forte pression exercée par le ressort d'aiguille (7) et le ressort de piston (8).
2.	Après avoir retiré l'aiguille, dévissez la buse (2-1) et retirez-la de sa siège, retirez le protège aiguille (12) du joint d'aiguille, dévissez l'écrou hexagonal du joint d'aiguille (11) et retirez-le du corps du pistolet.
3.	Pour retirer le piston (6-2), visser la section postérieure de l'aiguille (2-2) dans le piston (6-2) et retirez-le. Seulement dans le cas du <b>WA-200 ZP</b> , utilisez la vis d'extraction (17) pour retirer le piston du corps du pistolet. Faire attention à ne pas endommager le joint de piston (6-1) et le joint torique pendant le démontage du piston. <b>IMPORTANT: Pendant le remontage de piston, appliquer de la graisse sur le joint de piston (6-1) et sur le joint torique, afin d'éviter des empêchements au mouvement de piston lui-même.</b>
<b>IMPORTANT: AU REMONTAGE SUIVRE L'ORDRE INVERSE (3-2 et 1).</b>	

### 5.3 RECOMMANDATIONS IMPORTANTES

	Le réglage du presse étoupe (11) doit toujours être effectué avec l'aiguille (2-2) montée, c'est à dire de la façon suivante : fermer manuellement par une rotation de 60 degrés environ, puis serrer à l'aide de la clé de montage. Lors du retrait du presse étoupe (11), veiller à ne pas laisser le morceau en plastique du joint d'aiguille dans le corps du pistolet.
<b>IMPORTANT:</b> Tout vissage excessif du presse étoupe (11) risque d'empêcher le mouvement de l'aiguille (2-2) avec la fuite conséquente de peinture par l'extrémité de la buse (2-1). Régler avec douceur le serrage du presse étoupe (11) en contrôlant le mouvement de l'aiguille (2-2). Si le vissage est encore excessif, répéter de nouveau l'opération.	





**Lors du remplacement de la buse (2-1) et de l'aiguille (2-2), vérifiez le bon couplage des deux afin d'éviter éventuelles fuites de peinture au niveau de la buse pendant l'utilisation du pistolet.**

**Pendant le serrage du réglage produit (9) et de la buse (2-1) s'assurer toujours que le bouton de produit c'est complètement desserré.**

## 5.4 INSPECTIONS ET REMPLACEMENTS STANDARD

PARTIES À CONTRÔLER	PARTIES À REMPLACER
Chaque trou de passage du chapeau (1) et de la buse (2-1).	Remplacer s'ils sont écrasés ou déformés.
Joints et O'ring.	Remplacer s'ils sont déformés ou usurés.
Pertes des sections des logements entre la buse (2-1) et l'aiguille (2-2).	Remplacer si les fuites ne s'arrêtent pas même après que la buse (2-1) et l'aiguille (2-2) ont été complètement nettoyées. Si seules la buse (2-1) et l'aiguille (2-2) sont remplacées, vérifier l'accouplement correct des deux et l'absence de fuites éventuelles.

## 6. PROBLEMES ET SOLUTIONS

PROBLEME	SOLUTIONS	
<b>ABSENCE DE SORTIE DE PEINTURE</b>		
	Réglage produit (9) pas assez ouvert.	Vérifier et nettoyer.
	Trou de la buse (2-1) bouché.	Vérifier et nettoyer.
	Résidus de peinture entre l'aiguille (2-2) et le joint d'aiguille (11).	Vérifier et nettoyer.
<b>ATOMISATION PAR INTERMITTENCE</b>		
	Fuite d'air de la buse (2-1) et les logements du corps du pistolet.	Vérifier, nettoyer ou remplacer.
	Fuite d'air du presse étoupe (11).	Serrer.
	Fuite d'air du raccord du tuyau peinture.	Serrer.
	Résidus de peinture dans le chapeau (1).	Nettoyer
<b>DEFAUTS DU JET</b>		
	Buse (2-1) ou chapeau (1) incrustés de peinture.	Nettoyer soigneusement.
	Buse (2-1) ou chapeau (1) endommagés.	Remplacer.
	Buse (2-1) desserrée.	Serrer.
	Viscosité peinture trop élevée ou trop basse.	Diluer la peinture ou augmenter la viscosité.
	Le débit de la peinture est trop élevé ou trop faible.	Ajuster le bouton de réglage produit (9) pour réduire ou augmenter le débit.
<b>FUITES DE PEINTURE</b>		
	Buse (2-1), aiguille (2-2) ou corps pistolet incrustés, endommagés ou usés dans les logements.	Vérifier, nettoyer ou remplacer.
	Bouton de réglage produit (9) desserré.	Régler.
	Ressort d'aiguille (7) abimé.	Remplacer.
	Buse (2-1) desserrée.	Serrer.
	Presse étoupe (11) desserré, trop serré, sale ou usé.	Régler, nettoyer ou remplacer.
	La surface de la siège de piston (6-2) il est sale, endommagé ou usé.	Nettoyer ou remplacer.
	Le ressort de piston (8) est usé.	Remplacer.
	Le joint de piston (6-1) est usé.	Remplacer.

## 7. LISTE DES PIÈCES DÉTACHÉES

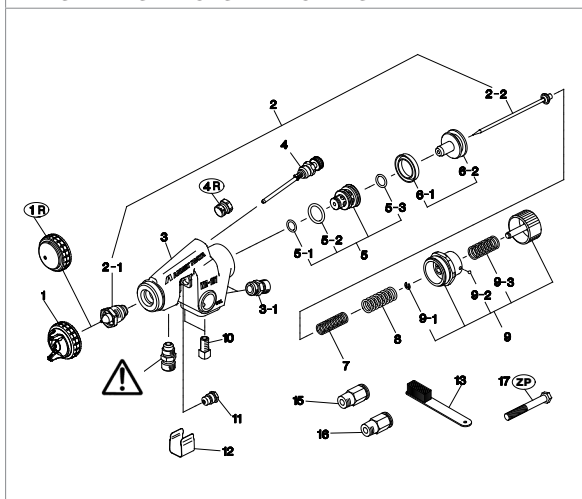

REP.	DESCRIPTION
1	CHAPEAU D'AIR
1R	CHAPEAU D'AIR (WA-101 R)
2-1	BUSE
2-2	AIGUILLE
3	CORPS DU PISTOLET
3-1	RACCORD D'AIR
4	RÉGLAGE FORME DU JET
4R	BOUCHON (WA-101 R)
5	GUIDE D'AIGUILLE
5-1	
5-2	JOINT TORIQUE
5-3	
6-1	JOINTS DE PISTON
6-2	PISTON
7	RESSORT D'AIGUILLE
8	RESSORT DE PISTON
9	RÉGLAGE PRODUIT
9-1	CIRCLIPS
9-2	BILLE
9-3	RESSORT RÉGLAGE PRODUIT
10	VIS DE FIXATION
11	PRESSE ÉTOUPE
12	PROTÈGE AIGUILLE
13	BROSSE
15	RACCORD RAPIDE Ø 6 (CYL)
16	RACCORD RAPIDE Ø 8 (CAP)
17	VIS D'EXTRACTION PISTON (WA-200 ZP)
•	Les parties signalées sont sujettes à usure.

### COMBINAISON BUSE ET AIGUILLE



MODÈLE	BUSE		AIGUILLE
	Taille ø mm	Marque	Marque
<b>WA-101</b>			
WA-101	0.8 (0.031)	W101/08	WA12
WA-101	1.0 (0.039)	W101/10	
WA-101 R	0.5 (0.020)	W101/05	WA05
<b>WA-200</b>			
WA-200	0.8 (0.031)	W200/08	WA12
WA-200	1.0 (0.039)	W200/10	
WA-200	1.2 (0.047)	W200/12	WA15
WA-200	1.5 (0.059)	W200/15	
WA-200	2.0 (0.079)	W200/20	
WA-200	2.5 (0.098)	W200/25	
<b>WA-200 WB</b>			
WA-200 WB	0.8 (0.031)	200WB/08	WA12
WA-200 WB	1.0 (0.039)	200WB/10	
WA-200 WB	1.2 (0.047)	200WB/12	WA15
WA-200 WB	1.4 (0.055)	200WBS1/14	
WA-200 WB	1.6 (0.063)	200WB/16	
<b>WA-200 ZP</b>			
WA-200 ZP	1.5 (0.059)	W200/15Z	-----
WA-200 ZP	2.0 (0.079)	W200/20Z	
WA-200 ZP	2.5 (0.098)	W200/25Z	
<b>LPA-200</b>			
LPA-200	1.8 (0.071)	L200/12	WA12





**NE JAMAIS DEMONTER LE RACCORD PRODUIT DU CORPS DU PISTOLET!** Tout mauvais fonctionnement résultant de la suppression de ce pièce ne sera pas couvert par la garantie. En cas de remplacement, contactez directement notre Service Technique.



En phase de commande veuillez préciser le modèle du pistolet, le nom de la pièce de rechange avec la référence numérique, le sigle du chapeau, de la buse et de l'aiguille.

	Antes de la instalación, del uso, ajuste o mantenimiento, es importante leer atentamente este manual de instrucciones. Guarde este manual en un lugar seguro para consulta futura.
  II 2G X	La pistola automática ANEST IWATA cumple con la normativa ATEX 2014/34/EU.
Nivel de protección II 2G X apto para el uso en las zonas 1 y 2. Marcado X: Es necesario desviar a tierra toda descarga de electricidad estática de la pistola de pulverización a través de la tubería de aire conductora como establecido.	







	<b>Cumpla SIEMPRE con las advertencias y las precauciones indicadas en este manual de instrucciones.</b>		
Símbolo	SIGNIFICADO	Nivel de peligro	Consecuencias
	ADVERTENCIA	Situación potencialmente peligrosa.	Grave peligro para la salud y la vida del operador.
	ATENCIÓN		Riesgo moderado para el operador y el equipo.
	IMPORTANTE		Daños materiales.

## 1. ESPECIFICACIONES TÉCNICAS







MODELOS	WA-200	WA-200 WB	WA-200 ZP	WA-101	WA-101 R	LPA-200
Máxima presión aire de trabajo:	7.0 bar (100 PSI)					
Nivel de ruido (LAeqT)*:	81.2 dB(A)	76.8 dB(A)	79.0 dB(A)	78.7 dB(A)	62.8 dB(A)	76.9 dB(A)
Conexión aire:	G1/4"					
Conexión fluido:	G1/4"	G1/4"	G3/8"	G1/4"	G1/4"	G3/8"
Temperatura máx:	Entorno: 5 ~ 40 °C - Aire/Fluido 5 ~ 43 °C					

\*Punto de medición: 1 m de la pistola, hacia atrás, altura 1.6 m.

### 1.1 DATOS TÉCNICOS

MODELOS							
<b>WA-200 WB</b>							
WA-200 WB-081P	0.8	WB1	1.6	200	340	360	470
WA-200 WB-101P	1.0			250			
WA-200 WB-121P	1.2			300			
WA-200 WB-141P	1.4						
WA-200 WB-161P	1.6						
<b>WA-200</b>							
WA-200-062	0.6	LV2	2.0	255	270	280	500
WA-200-084	0.8						
WA-200-104	1.0						
WA-200-124	1.2						
WA-200-154	1.5						
WA-200-082P	0.8	G2P	3.0	500	530	400	
WA-200-102P	1.0						
WA-200-122P	1.2						
WA-200-152P	1.5						
WA-200-202P	2.0						
WA-200-251P	2.5	R2		400	360	320	
		W1		500		330	
<b>WA-200 FLAT AND THIN® (Abanico Plano)</b>							
WA-200-066P FT	0.6	FT6	1.8	80	170	140	550
WA-200-086P FT	0.8			100	185	150	
WA-200-106P FT	1.0			120	200	160	
WA-200-126P FT	1.2			140	220	180	
<b>WA-200 ZP (para Pinturas Abrasivas)</b>							
WA-200-151ZP	1.5	R1Z	3.5	760	500	370	470
WA-200-201ZP	2.0						
WA-200-251ZP	2.5						
<b>WA-101</b>							
WA-101-082P	0.8	E2P	3.0	150	270	190	460
WA-101-102P	1.0	E2P		200	270	220	
WA-101-101P	1.0	E1		100	90	140	
WA-101-132P	1.3	H2		250	260	230	
<b>WA-101 R (Abanico Conico)</b>							
WA-101R-05P	0.5	RP	3.0	20	40	35	440
<b>LPA-200 HVLP</b>							
LPA-200-122P	1.2	G2	2.0	500	500	300	500
LPA-200-S5-12P	1.2	G2	2.0	250	560	250	

## 2. ADVERTENCIAS DE SEGURIDAD

<b>RIESGO DE INCENDIO Y EXPLOSIONES</b>	
<p><b>No utilice DISOLVENTES DE HIDROCARBONO HALOGENADO</b>, que pueden provocar grietas o fundir el cuerpo de la pistola de pulverización (aluminio) debido a reacciones químicas. DISOLVENTES INADECUADOS: cloruro de metileno, diclorometano, 1.2-dicloroetano, tetracloruro de carbono, tricloroetileno, 1.1.1-tricloroetano.</p>	  
<p><b>Se prohíbe estrictamente la presencia de chispas y llamas expuestas.</b> Los productos utilizados pueden ser altamente inflamables y pueden causar incendios. No los exponga a artefactos eléctricos, llamas expuestas, cigarrillos, etc.</p>	
<p>Conectar firmemente a tierra la pistola de pulverización utilizando la tubería de aire conductora. (Menor de 1MΩ). Verificar periódicamente la estabilidad de la puesta a tierra.</p>	
<b>PROTECCIÓN CORPORAL</b>	
<p><b>Utilice en un lugar bien ventilado, empleando la cabina de pulverización.</b> La mala ventilación puede provocar envenenamiento por disolventes orgánicos o incendios.</p>	  
<p><b>Utilice prendas protectoras (gafas de protección, máscara, guantes) para evitar la inflamación de los ojos y de la piel.</b> Si siente alguna molestia física, consulte a un médico de inmediato.</p>	
<p><b>Use tapones si fuera necesario.</b> El nivel de ruido puede superar los 80 dB(A), en función de las condiciones de funcionamiento y del lugar de trabajo.</p>	
<b>USO INADECUADO</b>	
<p><b>NO apunte la pistola hacia personas o animales.</b></p>	
<p><b>NO utilice una presión de trabajo ni una temperatura de funcionamiento superiores a las máximas.</b></p>	
<p><b>Descargue siempre la presión de aire y fluido antes las operaciones de limpieza, desmontaje y mantenimiento.</b> De no hacerlo así, la presión restante podría provocar lesiones personales debido al mal uso o a la difusión del líquido de limpieza. Para descargar la presión, cierre la alimentación del aire comprimido y de la pintura. Luego sólo suministre aire al pistón y descargue el material por medio de la aguja. Esta operación parará automáticamente el aire comprimido.</p>	
<p><b>La extremidad de la aguja es cortante.</b> Para evitar accidentes, no toque la punta durante el mantenimiento.</p>	
<p><b>No pulverice nunca productos alimenticios o químicos con esta pistola.</b> Si lo hace, elementos extraños podrían causar la erosión de los pasos del fluido, dañar la pistola y perjudicar la salud.</p>	
<p><b>No modifique nunca la pistola de pulverización,</b> para evitar daños que podrían afectar la calidad del resultado.</p>	
<p><b>En caso de problemas de funcionamiento, suspenda inmediatamente las operaciones de pulverización para localizar la avería. No utilice nuevamente el producto mientras el problema no esté resuelto.</b></p>	
<p><b>No entre nunca en las zonas de trabajo de los equipos (robots, reciprocadores, etc.) mientras no se hayan desactivado.</b> De lo contrario, el contacto con los equipos en funcionamiento podría ser la causa de accidentes y lesiones.</p>	

## 3. CONEXIÓN

	<p>Para alimentar la pistola, utilice aire filtrado y seco. El uso de aire no filtrado podría causar defectos durante las operaciones de pintura.</p>
<p>Cuando utilice por primera vez la pistola apenas comprada, limpie los conductos de material pulverizando un detergente compatible, para eliminar el aceite de protección contra la oxidación. De lo contrario, el aceite residual podría causar un mal funcionamiento de la pistola con los consiguientes defectos de pintura.</p>	
<p>Utilice una válvula de solenoide de tres vías con un diámetro de la sección interna superior a 4 mm y un tubo del aire con un diámetro interno superior a 6 mm y largo inferior a 10m. En caso contrario, si el diámetro de la válvula solenoide es demasiado pequeño y el tubo del aire entre la válvula y la pistola es demasiado largo, las operaciones pueden ser más lentas.</p>	
<p>Conecte firmemente el tubo en la pistola, para evitar que la desconexión o las pérdidas durante las operaciones de pulverización provoquen lesiones graves a las personas.</p>	

1. Fijar la pistola a el codillo de fijación, dirigir el chorro de pulverización y bloquee la pistola en la posición correcta por medio del perno de fijación.
2. Conecte firmemente el tubo del aire de pulverización en el lado del aire marcado por CAP, y el tubo del aire de funcionamiento en el lado del aire marcado por CYL.
3. Conectar firmemente la tubería del fluido a la conexión del fluido.
4. Suministre detergente a la pistola automática y pulverice para limpiar los conductos de pintura.
5. Suministre pintura a la pistola automática, verifique el chorro y ajuste el volumen del aire, el caudal del material y el abanico según sus exigencias.

### 3.1 CONEXIÓN DE LA TUBERÍA AIRE Y PINTURA

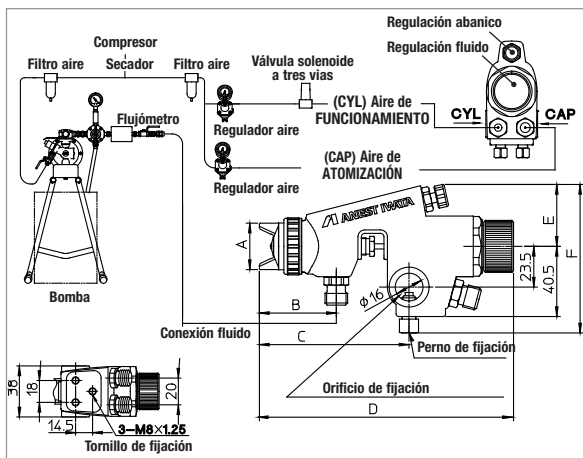

Dimensiones	MODELOS	A	B	C	D	E	F
	WA-200	30.5	47.5	89	148.5	36	86
WA-200 WB	30.5	47.5	89	148.5	36	86	
WA-101	27	44.5	85.5	147	36	86	
WA-101R	27	37.5	79	140.5	35	85	
LPA-200	30.5	47.5	89	148.5	36	86	

### 3.2 REEMPLAZO DE LAS CONEXIONES PARA INJERTOS RÁPIDOS

Retire la conexión aire para la atomización y la conexión aire para el funcionamiento, del cuerpo de la pistola. Reemplace la conexión de aire para la atomización (marcado CAP) con el injerto rápido para tubería de  $\varnothing$  8 mm (diámetro externo) y la conexión aire de funcionamiento (marcado CYL) con el injerto rápido para tubería de  $\varnothing$  6 mm (diámetro externo).

**SIEMPRE asegúrese de fijar firmemente los injertos rápido al cuerpo de la pistola.**

**IMPORTANTE:** Cuando se usa una tubería aire de 12 m (39.4 ft) de largo, su diámetro interno debe ser de al menos 8 mm (0,315) para atomizar a 7,0 bar (10 PSI) en el casquillo aire.

## 4. CÓMO OPERAR

1. Ajuste la presión aire de funcionamiento (CYL) entre los 3 y los 4 bar (57 y 71 PSI).
- NOTA:** El diámetro interno de la válvula de solenoide de tres vías debería ser  $\varnothing$  4 mm (0.157 in) como mínimo; el largo del tubo del aire de funcionamiento no debería sobrepasar los 10 m (32.8 ft) y su diámetro interno debería ser mayor de  $\varnothing$  6 mm (0.236 in) para evitar retrasos durante las operaciones y defectos en las aplicaciones.
2. La presión de atomización aire varía según las aplicaciones. Ajuste-la manteniendo el pistón presionado con la regulación abanico completamente abierta y registrando la presión de acuerdo con las indicaciones en la tabla de especificaciones técnicas. Solo en el caso de la pistola LPA 200, que esta una pistola HVLP, es necesario seguir las indicaciones de la presión aire en entrada para obtener una presión de atomización de 0,7 (10 PSI) interna en el casquillo aire.

3.	La viscosidad de la pintura aconsejada varía según las características de la pintura misma y las condiciones de trabajo. Se recomienda entre 15 y 23 segundos Ford Cup # 4.
4.	Ajuste la distancia entre la pistola y la pieza a procesar en un espacio estrecho y según el modelo de pistola: <b>WA-101 - WA-101R:</b> 150~200 mm (5.9~7.9 in)   <b>WA-200, WA-200WB y WA-200 ZP:</b> 200~250 mm (7.9~9.8 in)   <b>LPA-200</b> 100 ~ 200 mm (3.9 ~ 7.9 in). Puesto que la pistola <b>LPA 200 HVLP</b> funciona a baja presión, si el espacio entre la pistola y la pieza de trabajo está demasiado lejos, no se logrará la eficacia de transferencia correcta.

## 5. MANTENIMIENTO Y REVISIÓN

	<b>Antes de comenzar cualquier operación de revisión o de mantenimiento, lea y respete siempre escrupulosamente todas las indicaciones de las ADVERTENCIAS DE SEGURIDAD</b>
<b>No utilice nunca componentes o piezas de recambio que no sean originales ANEST IWATA.</b>	
<b>No estropee nunca los orificios del casquillo aire, del pico fluido ni las extremidades de la aguja.</b>	
<b>No sumerja nunca completamente la pistola en líquidos como el disolvente.</b>	
<b>No deje nunca el casquillo aire sumergida en el líquido de limpieza durante un periodo prolongado, ni siquiera durante la limpieza.</b>	

### 5.1 OPERACIÓN DE LIMPIEZA

	<b>Los conductos del fluido se deben limpiar cuidadosamente después del uso, sobre todo después del uso con pinturas bicomponentes. Una limpieza incompleta puede causar defectos en la forma del abanico.</b>
<b>Limpie todos los conductos del material y del grupo del casquillo aire (1). Pulverice una pequeña cantidad de detergente para limpiar los conductos de la pintura. Una limpieza incompleta puede causar defectos en la forma del abanico.</b>	
<b>Limpie cada sección utilizando la escobilla entregada embebida en detergente y secar con un paño absorbente. Nunca sumerja completamente la pistola en el detergente. Durante las operaciones de limpieza, tenga mucho cuidado con no rayar los orificios del grupo del casquillo aire, del pico fluido o la aguja.</b>	

### 5.2 PROCEDIMIENTO DE DESMONTAJE

<b>LIMPIE SIEMPRE LOS CONDUCTOS DE PINTURA ANTES DE DESMONTAR LA PISTOLA.</b>	
1.	Retire el casquillo aire (1), con la regulación fluido completamente abierta, desatornille la tuerca hexagonal y retire la regulación fluido (9), el muelle del pistón (8), el muelle de l'aguja (7), luego extraiga l'aguja (2-2) en línea recta desde el cuerpo de la pistola, para proteger la junta aguja (11). Durante esta fase, asegúrese de que la regulación fluido (9) no se empuja abruptamente, ya que está sujeto a una fuerte presión por el muelle de l'aguja (7) y el muelle del pistón (8).
2.	Después de quitar l'aguja, desenroscar el pico fluido (2-1) y quitarlo de su asiento, quitar la protección (12) de la junta aguja, desenroscar la tuerca hexagonal de la junta aguja (11) y sacarla del cuerpo de la pistola.
3.	Para quitar el pistón (6-2), atornille la sección trasera de la aguja (2-2) en el pistón (6) y extráigalo. Solo en el caso de la pistola <b>WA-200 ZP</b> , use el tornillo de extracción (17) para extraer el pistón del cuerpo de la pistola. Tenga cuidado de no dañar la junta del pistón (6-1) y la junta tórica durante la extracción. <b>IMPORTANTE: Al volver a montar el pistón, aplique grasa a la junta del pistón (6-1) y a la junta tórica (5-3), para evitar impedimentos al movimiento del pistón mismo.</b>
<b>IMPORTANTE:</b> <b>PARA MONTAR NUEVAMENTE EFECTÚE LAS OPERACIONES EN EL ORDEN DECRECIENTE. (3-2 e 1)</b>	

### 5.3 RECOMENDACIONES IMPORTANTES

	La regulación del grupo de las juntas de la aguja (11) siempre se debe llevar a cabo con la aguja (2-2) montada y de la manera siguiente: cierre manualmente y luego apriete con la llave adecuada girando 1/6 de vuelta (60 grados) aproximadamente. Quitando el grupo de las juntas de la aguja (11), no deje la pieza de plástico de la junta de la aguja en el cuerpo.
<b>IMPORTANTE:</b> Un apriete excesivo del grupo de las juntas de la aguja (11) puede impedir el movimiento de la aguja (2-2) con la consiguiente fuga de pintura por la extremidad del pico fluido (2-1). Regule lentamente, controlando el movimiento de la aguja (2-2). Si estuviera demasiado apretado, desenrózquelo y enrózquelo de nuevo cuidadosamente.	





**Cuando reemplace el pico fluido (2-1) y la aguja (2-2),** verificar el acoplamiento de ambos y comprobar que no hayan eventuales pérdidas de aire o de pintura del pico fluido durante el uso de la pistola.

**Al cerrar la regulación fluido (9) y el pico fluido (2-1),** comprobar siempre que la tuerca de la regulación fluido está completamente abierta.

### 5.4 REVISIÓN Y REEMPLAZO ESTÁNDAR

PIEZAS A CONTROLAR	PIEZAS A REEMPLAZAR
Todos los orificios de salida del casquillo aire (1) y del pico fluido (2-1).	Reemplazar si están aplastados o deformados.
Juntas y junta tórica.	Reemplazar si están aplastadas o deformadas
Fugas en los asientos entre el pico fluido (2-1) y la aguja (2-2).	Reemplazar si las fugas no se eliminan ni siquiera después de limpiar perfectamente el pico fluido (2-1) y la aguja (2-2). Si se reemplazan sólo el pico (2-1) y la aguja (2-2), se debe comprobar el correcto acoplamiento de las dos piezas y se debe controlar de la ausencia de fugas.

## 6. PROBLEMAS, CAUSAS Y SOLUCIONES

PROBLEMAS	SOLUCIONES	
<b>NO SALE PINTURA</b>		
	Tuerca de regulación fluido (9) abierta de manera insuficiente.	Controlar y regular.
	Orificio del pico fluido (2-1) obstruido.	Controlar y limpiar.
	Depósitos de pintura entre l'aguja (2-2) y la junta aguja (11).	Controlar y limpiar.
<b>PULVERIZACIÓN INTERMITENTE</b>		
	Pérdida de aire por el pico fluido (2-1).	Controlar, limpiar o reemplazar
	Pérdida de aire por el grupo juntas aguja (11).	Apretar.
	Pérdida de aire por la conexión de la tubería de la pintura.	Apretar.
	Depósito de pintura en el casquillo aire (1).	Limpiar.
<b>DEFECTOS DEL ABANICO</b>		
	Pico fluido (2-1) o casquillo aire (1) con pintura incrustada.	Limpiar esmeradamente.
	Pico fluido (2-1) o casquillo aire (1) dañados.	Reemplazar.
	Pico fluido (2-1) flojo.	Apretar.
	Viscosidad de la pintura demasiado alta o baja.	Diluir la pintura o aumentar la viscosidad.
	Caudal de la pintura demasiado alto o bajo.	Ajustar la tuerca de regulación (9) para disminuir o aumentar el caudal.
<b>PÉRDIDA DE PINTURA</b>		
	Pico fluido (2-1) , aguja (2-2) o cuerpo pistola, con pintura encostrada, estropeados o con el asiento desgastado.	Controlar, limpiar o reemplazar.
	Tuerca de regulación fluido (9) floja.	Regular.
	Muelle de presión aguja (7) desgastado.	Reemplazar.
	Pico fluido (2-1) flojo.	Apretar.
	Grupo juntas aguja (11) demasiado estrecho, sucio o desgastado.	Regular, limpiar o reemplazar.
	Superficie del asiento del grupo pistón (6-2) sucia, estropeada o desgastada.	Limpiar o reemplazar si hace falta.
	El muelle del pistón (8) está desgastado.	Reemplazar.
La junta del pistón (6-1) está desgastada.	Reemplazar.	

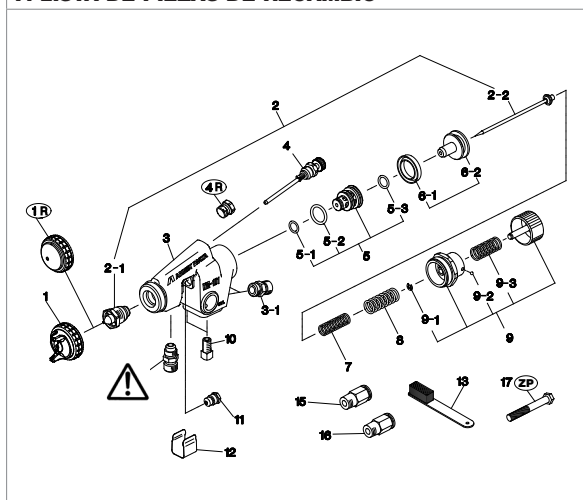

**7. LISTA DE PIEZAS DE RECAMBIO**

POS.	DESCRIPCIÓN	
1	CASQUILLO AIRE	
1R	CASQUILLO AIRE (WA-101 R)	
2-1	PICO FLUIDO	•
2-2	AGUJA	•
3	CUERPO PISTOLA	
3-1	CONEXIÓN AIRE	
4	GRUPO REGULACIÓN ABANICO	
4R	TAPÓN (WA-101 R)	
5	ASIENTO VÁLVULA AIRE	
5-1		
5-2	JUNTAS TÓRICAS	•
5-3		
6-1	JUNTA PISTÓN	•
6-2	PISTÓN	
7	MUELLE PRESIÓN AGUJA	
8	MUELLE PISTÓN	
9	GRUPO REGULACIÓN FLUIDO	
9-1	CIERRE E	
9-2	ESFERA	
9-3	MUELLE REGULACIÓN FLUIDO	
10	TUERCA DE FIJACIÓN	
11	CARTUCHO JUNTA AGUJA	•
12	PROTECCIÓN	
13	ESCOBILLA	
15	INJERTO RÁPIDO Ø 6 (CYL)	
16	INJERTO RÁPIDO Ø 8 (CAP)	
17	TORNILLO DE EXTRACCIÓN (WA-200 ZP)	
•	<b>Las piezas marcadas son piezas sometidas a desgaste.</b>	

**COMBINACIONES - PICO FLUIDO Y AGUJA**

MODELOS	PICO FLUIDO		AGUJA
	Tamaño Ø mm	Tipo	Tipo
<b>WA-101</b>			
WA-101	0.8 (0.031)	W101/08	
WA-101	1.0 (0.039)	W101/10	WA12
WA-101 R	0.5 (0.020)	W101/05	WA05
<b>WA-200</b>			
WA-200	0.8 (0.031)	W200/08	
WA-200	1.0 (0.039)	W200/10	WA12
WA-200	1.2 (0.047)	W200/12	
WA-200	1.5 (0.059)	W200/15	WA15
WA-200	2.0 (0.079)	W200/20	WA20
WA-200	2.5 (0.098)	W200/25	WA25
<b>WA-200 WB</b>			
WA-200 WB	0.8 (0.031)	200WB/08	
WA-200 WB	1.0 (0.039)	200WB/10	WA12
WA-200 WB	1.2 (0.047)	200WB/12	
WA-200 WB	1.4 (0.055)	200WBS1/14	
WA-200 WB	1.6 (0.063)	200WB/16	WA15
<b>WA-200 ZP</b>			
WA-200 ZP	1.5 (0.059)	W200/15Z	
WA-200 ZP	2.0 (0.079)	W200/20Z	-----
WA-200 ZP	2.5 (0.098)	W200/25Z	
<b>LPA-200</b>			
LPA-200	1.8 (0.071)	L200/12	WA12



**NUNCA quite la conexión de fluido del cuerpo de la pistola.** Cualquier avería resultante a causa de quitar estas partes no será cubierta por la Garantía. En caso de necesitar reemplazar estas partes contacte directamente con el Servicio Técnico.



Durante la fase de pedido se ruega especificar siempre el modelo de la pistola, el nombre del recambio con su número de referencia, y la sigla del casquillo de aire, del pico fluido y de la aguja.

 Antes de proceder à montagem, à entrada em serviço, ao ajuste ou às operações de manutenção, leia cuidadosamente o manual de instruções, que deve ser guardado para qualquer futura consulta.

  II 2G X A pistola automática ANEST IWATA está em conformidade com a norma 2014/34/EU.

Nível de protecção: categoria II 2G X adaptado para o uso nas Áreas 1 e 2.

Marcação X: a electricidade estática deve ser descarregada da pistola e desviada para terra através do tubo de condução do ar, conforme indicado.







	<b>Assegure-se de respeitar SEMPRE as advertências para a segurança, contidas no manual de instruções acima mencionado.</b>		
Símbolo	SIGNIFICADO	NÍVEL DE PERIGO	CONSEQUÊNCIAS
	<b>ADVERTÊNCIAS</b>	<b>SITUAÇÃO POTENCIALMENTE PERIGOSA</b>	Riscos graves para a saúde e a vida do operador.
	<b>CUIDADO</b>		Riscos moderados para o produto e o operador.
	<b>IMPORTANTE</b>		Danos materiais.

## 1. ESPECIFICAÇÕES TÉCNICAS

MODELO	WA-200	WA-200 WB	WA-200 ZP	WA-101	WA-101 R	LPA-200
Máx. pressão ar de utilização:	7.0 bar (100 PSI)					
Ruído (LAeqT)*:	81.2 dB(A)	76.8 dB(A)	79.0 dB(A)	78.7 dB(A)	62.8 dB(A)	76.9 dB(A)
Conector de ar:	G1/4"					
Conector de fluido:	G1/4"	G1/4"	G3/8"	G1/4"	G1/4"	G3/8"
Temperatura Máxima:	Ambiente 5 ~ 40 °C / Ar-Fluído 5 ~ 43 °C					

\*Ponto de medição: 1 m atrás da pistola, 1,6 m de altura.

### 1.1 DATOS TÉCNICOS

MODELOS							
<b>WA-200 WB</b>							
WA-200 WB-081P	0.8	WB1	1.6	200	340	360	470
WA-200 WB-101P	1.0			250			
WA-200 WB-121P	1.2			300			
WA-200 WB-141P	1.4						
WA-200 WB-161P	1.6						
<b>WA-200</b>							
WA-200-062	0.6	LV2	2.0	255	270	280	500
WA-200-084	0.8						
WA-200-104	1.0						
WA-200-124	1.2						
WA-200-154	1.5	G2P	3.0	500	530	400	
WA-200-082P	0.8						
WA-200-102P	1.0						
WA-200-122P	1.2						
WA-200-152P	1.5						
WA-200-202P	2.0						
WA-200-251P	2.5	R2		400	360	320	
		W1		500		330	
<b>WA-200 FLAT AND THIN® (com Leque Plano)</b>							
WA-200-066P FT	0.6	FT6	1.8	80	170	140	550
WA-200-086P FT	0.8			100	185	150	
WA-200-106P FT	1.0			120	200	160	
WA-200-126P FT	1.2			140	220	180	
<b>WA-200 ZP (para Tinta Abrasiva)</b>							
WA-200-151ZP	1.5	R1Z	3.5	760	500	370	470
WA-200-201ZP	2.0						
WA-200-251ZP	2.5						
<b>WA-101</b>							
WA-101-082P	0.8	E2P	3.0	150	270	190	460
WA-101-102P	1.0	E2P		200	270	220	
WA-101-101P	1.0	E1		100	90	140	
WA-101-132P	1.3	H2		250	260	230	
<b>WA-101 R (com Leque Cônicos)</b>							
WA-101R-05P	0.5	RP	3.0	20	40	35	440
<b>LPA-200 HVLP</b>							
LPA-200-122P	1.2	G2	2.0	500	500	300	500
LPA-200-S5-12P	1.2	G2	2.0	250	560	250	

## 2. ADVERTÊNCIAS DE SEGURANÇA

<b>RISCOS DE INCÊNDIOS E EXPLOSÕES</b>	
Nunca utilize SOLVENTES HIDROCARBONETOS HALOGENADOS, que poderiam causar danos e dissolução das partes em alumínio do corpo da pistola, provocados por reacções químicas. SOLVENTES INCOMPATÍVEIS: cloreto de metileno, diclorometano, 1.2-dicloroetano, tetracloreto de carbono, tricloroetileno, 1.1.1-tricloroetano.	
É estritamente proibido produzir chamas livres e faíscas. Os produtos utilizados podem ser muito inflamáveis e, portanto, provocar graves incêndios, como, por exemplo, fumar, provocar faíscas ou qualquer risco eléctrico.	
Ligue correctamente ao fio de terra a pistola para a pintura, utilizando um tubo de condução do ar (<1MΩ). Controle periodicamente a estabilidade da ligação ao fio de terra.	
<b>RISCOS PARA A SAÚDE</b>	
Utilize a pistola para a pintura em ambientes correctamente ventilados, usando a cabine de pintura. Uma ventilação não adequada ou insuficiente poderia provocar uma intoxicação devido a solventes orgânicos ou causar incêndios.	  
Vista sempre roupa de protecção (óculos de protecção, máscara, luvas). Para evitar que o contacto com os materiais irritantes possa provocar inflamações nos olhos e na pele. Caso houver mesmo o mínimo risco de dano físico, consulte imediatamente um médico.	
Se for necessário, use tampões de ouvidos. O nível de ruído pode ultrapassar os 80 dB(A) e depende das condições de utilização e da área de trabalho.	
<b>RISCOS DE USO IMPRÓPRIO</b>	
NUNCA aponte a pistola em direcção de pessoas ou animais.	
NUNCA ultrapasse a pressão ou a temperatura máxima de utilização.	
Descarregue sempre a pressão do ar e do material, antes das operações de limpeza, montagem e manutenção. Ao contrário, a pressão residual poderia causar feridas no corpo provocadas por operações não correctas ou pela pulverização dos líquidos usados para a limpeza. Para descarregar a pressão, feche a alimentação do ar comprimido e da tinta. Depois, alimente de ar somente o pistão e descarregue o material, operando na agulha. Esta acção provocará a paragem automática do ar comprimido.	
A ponta da agulha do produto é afiada. Para não correr o risco de ferir-se, não toque a agulha durante as operações de manutenção.	
Nunca pulverize produtos alimentares ou químicos com esta pistola. Ao contrário, a mistura de substâncias estranhas poderia causar a corrosão das passagens da tinta, com consequentes danos na pistola e riscos para a saúde.	
Nunca modifique a pistola para pintura, para evitar danificações que poderiam prejudicar a qualidade do resultado.	
No caso de maus funcionamentos interrompa imediatamente as operações de pintura para a procura da avaria. Não utilize novamente o produto até ter resolvido o problema.	
Nunca entre nas áreas de trabalho dos equipamentos (p. ex., robô, reciprocadores, etc.) até as mesmas forem desactivadas. Ao contrário, o contacto com os equipamentos em função poderia causar acidentes e ferimentos.	

## 3. CONEXÃO

	Para alimentar a pistola utilize ar filtrado e seco. O uso de ar não filtrado pode causar defeitos de pintura.
Ao usar a pistola pela primeira vez após a compra, limpe as passagens de tinta pulverizando um limpador compatível para remover o óleo anti-ferrugem. Ao contrário, o óleo residual pode provocar uma avaria do aparelho com consequentes defeitos de pintura.	
Utilize uma válvula solenóide de três vias, cujo diâmetro da secção interna deve ser maior de 4 mm e uma tubulação de ar com um diâmetro interno maior de 6 mm e com comprimento não superior a 10 m. Ao contrário, uma válvula solenóide com um diâmetro demasiado pequeno e uma tubulação de ar de comprimento excessivo entre a válvula e a pistola, poderiam causar atrasos nas operações.	
Conecte solidamente a tubulação à pistola, para evitar que a desconexão da mesma ou os vazamentos durante as operações de pintura provoquem feridas graves no corpo.	

1. Monte a pistola no suporte de fixação, direcione o jacto de pintura e bloqueie a pistola na posição correcta, mediante o parafuso de fixação.
2. Conecte solidamente a tubulação de ar de atomização ao lado ar com a sigla CAP e a tubulação de ar de funcionamento ao lado de ar com a sigla CYL.
3. Conecte solidamente o tubo material ao conector do produto.
4. Alimente a pistola automática com detergente compatível e pulverize para limpar as passagens da tinta.
5. Alimente a pistola automática com a tinta, verifique a pulverização e regule o volume do ar, a vazão do material e o leque, conforme as exigências.

### 3.1 CONEXÃO DO TUBO DE AR E DA TINTA

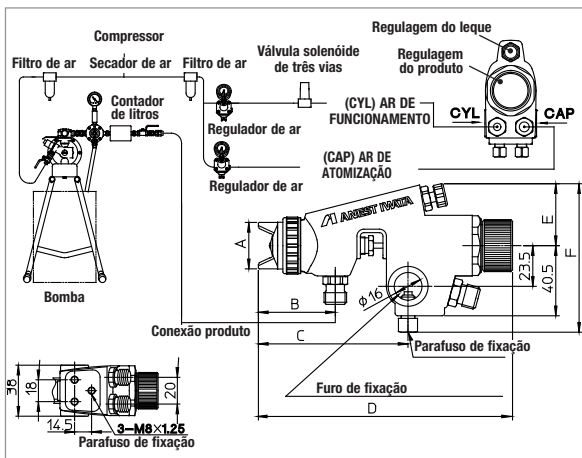

Dimensões	MODELOS	A	B	C	D	E	F
	WA-200	30.5	47.5	89	148.5	36	86
WA-200 WB	30.5	47.5	89	148.5	36	86	
WA-101	27	44.5	85.5	147	36	86	
WA-101R	27	37.5	79	140.5	35	85	
LPA-200	30.5	47.5	89	148.5	36	86	

### 3.2 SUBSTITUINDO ACOPLAMENTOS RÁPIDOS OPCIONAIS

Remova o conexão do ar de atomização e o conexão do ar de funcionamento do corpo da pistola. Substitua o conexão do ar de atomização marcado CAP com o acoplamento rápido para tubulação  $\phi$  8 mm (diâmetro externo) e o conexão do ar de funcionamento marcado CYL com o acoplamento rápido para tubulação  $\phi$  6 mm (diâmetro externo).

**SEMPRE certifique-se de fixar firmemente os acoplamentos rápidos ao corpo da pistola.**

**IMPORTANTE:** Ao usar um tubo de ar longo 12 m (39,4 pés), seu diâmetro interno deve ser de pelo menos 8 mm (0,315), para atomizar em 7.0 bar (10 PSI) no espalhador.

## 4. COMO OPERAR

1. Regule a pressão do ar de funcionamento (CYL) entre 3 e 4 bares (43~57 PSI).

**NOTA:** O diâmetro interno da válvula solenóide de três vias deveria medir no mínimo  $\phi$  4 mm (0.157 in) e o comprimento do tubo de ar de funcionamento não deveria ser maior de 10 m (32.8 ft) e ter um diâmetro interno maior de  $\phi$  6 mm (0.236 in) para evitar atrasos durante as operações e defeitos nas aplicações.

2. A pressão de atomização do ar varia de acordo com as aplicações. Para ajustá-lo, é necessário manter pressionado o pistão com o ajuste do leque completamente aberto e registrá-lo de acordo com as indicações na tabela de especificações técnicas.  
Somente no caso de a pistola **LPA 200 HVLP**, será necessário seguir a indicação da pressão de ar recebida para obter uma pressão de atomização de 0,7 (10 PSI) dentro do bico de ar.

3.	A correta viscosidade da tinta depende das propriedades da pintura e das condições de pintura; se recomenda entre 15 e 23 segundos Ford Cup#4.
4.	Calibre a distância de pulverização entre a pistola e a peça de trabalho, possivelmente num espaço restrito e compreendido entre: 150~200 mm (5.9~7.9 in) no caso da <b>WA-101</b> e <b>WA-101R</b> , entre 200~250 mm (7.9 a 9.8 in) no caso da <b>WA-200</b> , <b>WA-200WB</b> e <b>WA-200 ZP</b> , entre 100~200 mm (3.9~7.9 in) no caso da <b>LPA-200</b> . Como a pistola LPA 200 HVLP funciona a baixa pressão, se o espaço entre a pistola e a peça de trabalho estiver muito distante, a eficiência de transferência correta não será alcançada.

## 5. MANUTENÇÃO E INSPEÇÃO

	Antes de proceder a qualquer operação de inspeção e manutenção, leia sempre e respeite escrupulosamente todas as indicações sobre as Advertências de segurança.
Nunca utilize outros componentes ou peças sobresselentes que não sejam aqueles originais da ANEST IWATA.	
Nunca danifique os furos do bico do ar, do bico do produto e a extremidade da agulha.	
Nunca mergulhar completamente a pistola nos líquidos como os solventes.	
Nunca deixe imergido o bico do ar no líquido de limpeza por um período prolongado, também durante a limpeza.	

### 5.1 PROCEDIMENTO DE LIMPEZA

	As passagens do material devem ser cuidadosamente limpos após cada utilização da pistola e especialmente após o uso de tintas de dois componentes. Uma limpeza incompleta poderia causar defeitos à forma do leque.
Limpe todas as passagens do material e do espalhador (1). Pulverize uma pequena quantidade de detergente para limpar as passagens da tinta. Uma limpeza incompleta pode provocar defeitos à forma do leque.	
Limpe cada secção com uma escova humedecida de detergente e um pano absorvente. Nunca mergulhar completamente a pistola no detergente, dado que isso poderia causar danos ao produto. Durante a limpeza evite arranhar as superfícies dos furos do bico do ar, do bico do material e a agulha.	

### 5.2 DESMONTAGEM E MONTAGEM

<b>ANTES DA DESMONTAGEM DA PISTOLA LIMPE SEMPRE TODAS AS PASSAGENS DA TINTA.</b>	
1.	<b>Remova o espalhador</b> (1), com o ajuste do produto completamente aberto, desenrosque a porca hexagonal de ajuste e remova o conjunto de ajuste do produto (9), a mola do pistão (8), a mola da agulha (7) em seguida, extraie a agulha (2-2) em linha reta do corpo da pistola, para proteger o conjunto de juntas da agulha (11). Preste atenção para que o ajuste da agulha (7) não seja empurrado para fora bruscamente, dado que está sujeito a uma forte pressão devido à mola da agulha (7) e à mola do pistão (8).
2.	Depois de retirar a agulha, desenrosque o bico do produto (2-1) e retire-o da caixa, retire a proteção (12) da junta da agulha, desenrosque a porca hexagonal da junta agulha (11) e tire-a do corpo da pistola.
3.	Para remover o pistão (6-2), aperte a parte traseira da agulha (2-2) no pistão e puxe-a para fora. Somente no caso da <b>WA-200 ZP</b> , use o parafuso de extração (17) para retirar o pistão do corpo da pistola. Tenha cuidado para não danificar a junta do pistão (6-1) e o O'ring durante a remoção. <b>IMPORTANTE: Ao remontar o pistão, aplique graxa na junta do pistão (6-1) e O'ring (5-3), para evitar impedimentos ao movimento do pistão.</b>
<b>IMPORTANTE: PARA REMONTAR, PROCEDA NO MODO INVERTIDO.</b>	

### 5.3 RECOMENDAÇÕES IMPORTANTES

	A regulagem do conjunto de juntas da agulha (11) deve sempre ser efectuada com a agulha (2-2) montada e na seguinte maneira: feche manualmente e depois aperte com a chave apropriada por cerca de 1/6 de rotação (60 graus). Quando remover o conjunto de juntas da agulha (11), não deixe a peça de plástico do conjunto de juntas da agulha dentro do corpo.
<b>IMPORTANTE:</b> Um aperto excessivo do conjunto de juntas da agulha (11), pode provocar um impedimento no movimento da agulha (2-2), com conseqüente vazamento de tinta da extremidade do bico do produto (2-1). Regule lentamente, controlando o movimento da agulha (2-2). Se resultar excessivamente apertado, desaperte-o completamente e aperte-o novamente com cuidado.	





**Ao substituir o bico do produto (2-1) e a agulha (2-2),** verifique o acoplamento correto de ambos para evitar qualquer vazamento de tinta do bico do produto, durante as operações de pintura.

**Ao fechar do ajuste do produto (9) e do bico do produto (2-1),** verifique sempre de que o botão de ajuste do produto esteja completamente solto.

## 5.4 INSPECÇÕES & SUBSTITUIÇÕES PADRÕES

PEÇAS A CONTROLAR	PEÇAS A SUBSTITUIR
Cada furo de passagem do espalhador (1) e do bico do produto (2-1).	Substitua se forem esmagados ou deformados.
Juntas e O'ring.	Substitua se forem deformadas ou desgastadas.
Vazamentos das secções das sedes entre o bico do produto (2-1) e a agulha (2-2).	Substitua-os se os vazamentos não param mesmo após que o bico do produto (2-1) e a agulha (2-2) forem completamente limpos. Se substituí somente o bico do produto (2-1) e a agulha (2-2), verifique o correcto acoplamento de ambos e certifique-se que não tenham eventuais vazamentos.

## 6. PROBLEMAS, CAUSAS E SOLUÇÕES

PROBLEMAS	SOLUÇÕES	
<b>FALTA DE SAÍDA DE TINTA</b>		
	Botão de ajuste do produto (9) não suficientemente aberto.	Verifique e ajuste.
	Furo do bico do produto (2-1) obstruído.	Verifique e limpe.
	Acúmulo de tinta entre a agulha (2-2) e o conjunto da juntas da agulha (11).	Verifique e limpe.
<b>ATOMIZAÇÃO A INTERMITÊNCIA</b>		
	Vazamento de ar do bico do produto (2-1).	Verifique, limpe ou substitua.
	Vazamento de ar da junta da agulha (11).	Aperte.
	Vazamento de ar do junção do tubo da tinta.	Aperte.
	Resíduos de tinta no espalhador (1).	Limpe.
<b>DEFEITOS NO LEQUE</b>		
	Bico do produto (2-1) ou espalhador (1) incrustados da tinta.	Limpe-os cuidadosamente.
	Bico do produto (2-1) ou espalhador (1) danificados.	Substitua-os.
	Bico do produto (2-1) afrouxado.	Aperte.
	Viscosidade da tinta demais elevada ou demais baixa.	Dilua a tinta ou aumente a viscosidade.
	O fluxo da tinta demais elevado ou demais baixo.	Actue no botão ajuste do produto (9) para reduzir ou aumentar o fluxo.
<b>VAZAMENTO DA TINTA</b>		
	Bico do produto (2-1), agulha (2-2) ou corpo, incrustados danificados ou desgastados na sede.	Verifique, limpe ou substitua.
	Botão ajuste do produto (9) afrouxado.	Ajuste.
	Mola da agulha (7) desgastada.	Substitua-a.
	Bico do produto (2-1) afrouxado.	Aperte.
	Junta da agulha (11) afrouxada, demais estreita, suja ou desgastada.	Ajuste, limpe ou substitua.
	A superfície do assento do pistão (6-2) está suja, danificada ou desgastada.	Limpe ou substitua.
	A mola do pistão (8) está desgastada.	Substitua.
	A junta do pistão (6-1) está desgastada.	Substitua.

## 7. LISTA PEÇAS SOBRESSALENTES

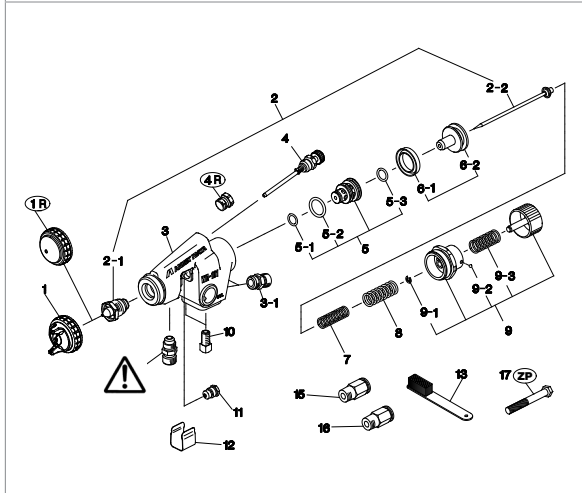

POS.	DESCRIÇÃO
1	ESPALHADOR
1R	ESPALHADOR (WA-101 R)
2-1	BICO DO PRODUTO
2-2	AGULHA
3	CORPO DA PISTOLA
3-1	CONECTOR DO AR
4	AJUSTE DO LEQUE
4R	TAMPA (WA-101 R)
5	ASSENTO DA VÁLVULA DE AR
5-1	O RING
5-2	
5-3	
6-1	JUNTA PISTÃO
6-2	PISTÃO
7	MOLA DA AGULHA
8	MOLA DA PISTÃO
9	AJUSTE DO PRODUTO
9-1	ANEL DE RETENÇÃO
9-2	BOLA
9-3	MOLA DO AJUSTE DO PRODUTO
10	PARAFUSO DE FIXAÇÃO
11	CARTUCHO JUNTAS DA AGULHA
12	PROTEÇÃO
13	ESCOVA
15	ACOPLAMENTO RÁPIDO Ø 6 (CYL)
16	ACOPLAMENTO RÁPIDO Ø 8 (CAP)
17	PARAFUSO DE EXTRAÇÃO (WA-200 ZP)
•	<b>As peças marcadas são sujeitas a desgaste.</b>

### COMBINAÇÃO BICO DO PRODUTO E AGULHA

MODELOS	BICO DO PRODUTO		AGULHA
	Tamanho Ø mm	Marca	Marca
<b>WA-101</b>			
WA-101	0.8 (0.031)	W101/08	WA12
WA-101	1.0 (0.039)	W101/10	
WA-101 R	0.5 (0.020)	W101/05	WA05
<b>WA-200</b>			
WA-200	0.8 (0.031)	W200/08	WA12
WA-200	1.0 (0.039)	W200/10	
WA-200	1.2 (0.047)	W200/12	
WA-200	1.5 (0.059)	W200/15	WA15
WA-200	2.0 (0.079)	W200/20	WA20
WA-200	2.5 (0.098)	W200/25	WA25
<b>WA-200 WB</b>			
WA-200 WB	0.8 (0.031)	200WB/08	WA12
WA-200 WB	1.0 (0.039)	200WB/10	
WA-200 WB	1.2 (0.047)	200WB/12	
WA-200 WB	1.4 (0.055)	200WBS1/14	WA15
WA-200 WB	1.6 (0.063)	200WB/16	
<b>WA-200 ZP</b>			
WA-200 ZP	1.5 (0.059)	W200/15Z	-----
WA-200 ZP	2.0 (0.079)	W200/20Z	
WA-200 ZP	2.5 (0.098)	W200/25Z	
<b>LPA-200</b>			
LPA-200	1.8 (0.071)	L200/12	WA12



**NUNCA REMOVER O CONECTOR DO PRODUTO DO CORPO DA PISTOLA!** Quaisquer avarias resultantes da remoção destas peças não serão cobertos pela Garantia. Em caso de substituição, contacte o seu Serviço Técnico diretamente.



Ao ordenar pede-se sempre de especificar o modelo da pistola, o nome da peça sobressalente com o referimento numerico, a sigla do espalhador, do bico do produto e da agulha.

	Bevor Sie das Gerät einsetzen, einschalten, regulieren oder warten, lesen Sie diese Betriebsanleitung sorgfältig, die für jeden zukünftigen Hinweis erhalten werden muss.
  II 2G X	Die ANEST IWATA automatische Spritzpistole ist in Übereinstimmung mit den Rechtsvorschriften ATEX 2014/34/EU.
Schutzgrad: Gerätekategorie II 2G X geeignet für den Gebrauch in den Zonen 1 und 2. X-Kennzeichnung: Die statische Elektrizität muss von der Pistole entladen und durch den leitenden Luftschlauch geerdet werden.	







	Beachten Sie <b>IMMER</b> die Sicherheitshinweise, die in dieser Betriebsanleitung enthalten sind.		
SYMBOL	BEDEUTUNG	GEFAHRENNIVEAU	FOLGEN
	WARNHINWEISE	POTENTIELL GEFÄHRLICHE SITUATION.	Hohe Risiken für die Gesundheit und das Leben des Bedieners.
	VORSICHTIG		Mäßige Risiken für Produkt und Bediener.
	WICHTIG		Materielle Schäden.

## 1. TECHNISCHE SPEZIFIKATIONEN

MODELLE	WA-200	WA-200 WB	WA-200 ZP	WA-101	WA-101 R	LPA-200
Max. Betriebsdruck:	7.0 bar (100 PSI)					
Geräuschpegel (LAeqT)*:	81.2 dB(A)	76.8 dB(A)	79.0 dB(A)	78.7 dB(A)	62.8 dB(A)	76.9 dB(A)
Luftanschluss:	G1/4"					
Materialanschluss:	G1/4"	G1/4"	G3/8"	G1/4"	G1/4"	G3/8"
Max. Temperatur:	Raum 5 ~ 40 °C - Luft/Flüssigkeit 5 ~ 43 °C					

\* Messpunkt: 1 m hinter der Pistole, 1.6 m Höhe

### 1.1 TECHNISCHE DATEN

MODELLE							
<b>WA-200 WB</b>							
WA-200 WB-081P	0.8	WB1	1.6	200 250 300	340	360 380 340	470
WA-200 WB-101P	1.0						
WA-200 WB-121P	1.2						
WA-200 WB-141P	1.4						
WA-200 WB-161P	1.6						
<b>WA-200</b>							
WA-200-062	0.6	LV2	2.0	255	270	280	500
WA-200-084	0.8						
WA-200-104	1.0						
WA-200-124	1.2						
WA-200-154	1.5	G2P	3.0	500 270 400 500	530 330 360	400 340 320 330	
WA-200-082P	0.8						
WA-200-102P	1.0						
WA-200-122P	1.2						
WA-200-152P	1.5						
WA-200-202P	2.0						
WA-200-251P	2.5	R2	W1				
<b>WA-200 FLAT AND THIN® (mit Flachstrahl)</b>							
WA-200-066P FT	0.6	FT6	1.8	80 100 120 140	170 185 200 220	140 150 160 180	550
WA-200-086P FT	0.8						
WA-200-106P FT	1.0						
WA-200-126P FT	1.2						
<b>WA-200 ZP (für Abrasive Materialien)</b>							
WA-200-151ZP	1.5	R1Z	3.5	760	500	370	470
WA-200-201ZP	2.0						
WA-200-251ZP	2.5						
<b>WA-101</b>							
WA-101-082P	0.8	E2P	3.0	150 200 100 250	270 270 90 260	190 220 140 230	460
WA-101-102P	1.0	E2P					
WA-101-101P	1.0	E1					
WA-101-132P	1.3	H2					
<b>WA-101 R (mit Rundstrahl)</b>							
WA-101R-05P	0.5	RP	3.0	20	40	35	440
<b>LPA-200 HVLP</b>							
LPA-200-122P	1.2	G2	2.0	500	500	300	500
LPA-200-S5-12P	1.2	G2	2.0	250	560	250	



## 2. SICHERHEITSHINWEISE

<b>EXPLOSIONS- UND FEUERGEFAHR</b>	
Niemals <b>HALOGENKOHLENWASSERSTOFFLÖSUNGSMITTEL</b> verwenden, das durch chemische Reaktionen zur Auflösung des Pistolenkörpers aus Aluminium führen könnte. <b>UNGEEIGNETE LÖSUNGSMITTEL:</b> Methylchlorid, Dichlormethan, 1,2 Dichloroethan, Tetrachlorkohlenstoff, Trichloräthylen.	
<b>Funken und offene Flammen sind strikt zu vermeiden.</b> Die verwendeten Produkte sind leicht entzündlich und können deshalb Brände auslösen. Niemals offenen Flammen, elektrischen Geräten, Zigaretten, u.ä. aussetzen.	
<b>Lackierpistole sicher mittels Erdungskabel erden.</b> (<1MΩ) Stets sicherstellen, dass die Lackierpistole korrekt geerdet ist.	
<b>GESUNDHEITSSCHUTZ</b>	
Der Arbeitsplatz muss über eine gute Ventilation verfügen; verwenden Sie die Pistole in einer Lackierkabine. Bei unzureichender Ventilation kann es zu einer Vergiftung mit organischen Lösungsmitteln oder Feuer kommen.	
<b>Tragen Sie immer Schutzausrüstung (Schutzbrille, Schutzmaske und Handschuhe),</b> um Augen- und Hautentzündungen zu vermeiden. Falls Beschwerden auftreten, suchen Sie sofort einen Arzt auf.	
Falls nötig, sollten Sie Gehörschutz anwenden. Der Geräuschpegel kann je nach Arbeitsbedingungen und Standort 80 dB(A) übersteigen.	
<b>UNSACHGEMÄSSE ANWENDUNG</b>	
Zielen Sie niemals die Pistole auf Menschen oder Tiere.	
<b>Überschreiten Sie nie den maximalen Arbeitsdruck oder die maximale Arbeitstemperatur.</b>	
<b>Vor Reinigung, Auseinandernehmen und Wartung lassen Sie immer den Luft- und Flüssigkeitsdruck ab.</b> Andernfalls kann der verbleibende Druck Verletzungen wegen der unsachgemäßen Anwendung und des Ausstoßens der Reinigungsflüssigkeit verursachen. Um den Druck auszublasen, die Druckluftversorgung und den Lackzufuhr trennen. Danach nur den Kolben mit Luft zuführen und das Material mittels der Nadel auslassen. Dieser Verfahren verursacht das automatische Anhalten der Druckluft.	
<b>Die Nadel ist oben spitz.</b> Um Zwischenfälle zu vermeiden, berühren Sie die Spitze niemals während Wartungsarbeiten.	
<b>Verwenden Sie niemals die Pistole zum Spritzen von Lebensmitteln oder Chemikalien.</b> Andernfalls könnten ungeeignete Substanzen zu Korrosion der Flüssigkeitsleitungen und damit zu Gesundheitsschäden führen.	
<b>Verändern Sie nie die Lackierpistole,</b> um Beschädigungen zu vermeiden, welche die Qualität des Ergebnisses beeinträchtigen könnten.	
<b>Bei Funktionstörungen unterbrechen Sie die Lackiervorgänge sofort, um den Defekt festzustellen. Das Produkt nicht erneut verwenden, solange das Problem nicht gelöst ist.</b>	
<b>Betreten Sie nie die Arbeitsbereiche der Maschinen (wie Roboter, Bewegungsautomaten, usw.), solange diese nicht ausgeschaltet sind.</b> Bei Zuwiderhandlung könnte der Kontakt mit den laufenden Maschinen zu Unfällen und Verletzungen führen.	

## 3. VERBINDUNG

	Um die Pistole zu versorgen, verwenden Sie gefilterte und trockene Luft. Es wird der Einsatz eines Filters mit automatischem Kondenswasserablass und Trockner empfohlen.
<b>WIRD DIE PISTOLE DAS ERSTE MAL VERWENDET, REINIGEN SIE DIE MATERIALDURCHFLOSSVORRICHTUNGEN UND ENTFERNEN SIE DAS ROSTSCHUTZÖL.</b>	
Ein Dreiweg- Solenoidventil mit Innendurchmesser größer als 4mm und einen Luftschlauch mit Innendurchmesser größer als 6 mm und Länge nicht höher als 10m verwenden. Kleinere Innendurchmesser des Solenoidventils und längeren Luftschlauch zwischen Ventil und Spritzpistole könnten Verspätungen der Vorgänge verursachen.	
<b>Den Schlauch fest an die Pistole anschließen, um zu verhindern, dass das Ablösen desselben oder die Verlüste während der Spritzvorgänge schwere Körperverletzungen verursachen.</b>	

1. Montieren die Spritzpistole auf die Halterung den Spritzstrahl ausrichten und die Spritzpistole in der richtigen Position mittels des Verankerungsbolzens blockieren.
2. Den Luftschlauch an die Zerstäuberluftseite (mit dem Kennzeichen CAP), und den Betriebsluftschlauch an die Betriebsluftseite (mit dem Kennzeichen CYL) fest anschließen.
3. Befestigen Sie das Farbversorgungsrohr dem Materialanschluss verbinden.
4. Säubern Sie die Materialdurchflussvorrichtungen der Pistole mit kompatibelem Reinigungsmittel.
5. Die automatische Spritzpistole mit Lack zuführen, den Spritzer prüfen und die Luftmenge, die Materialfördermenge und die Spritzstrahl nach Ihren Anforderungen regulieren.

### 3.1 VERBINDUNG DER LUFT UND DER FARBLINIE

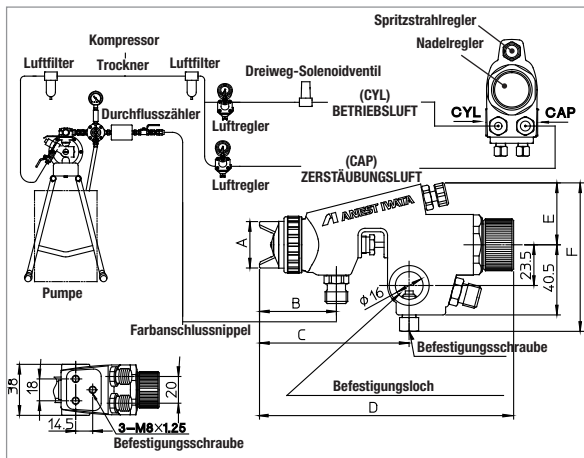

	MODELLE	A	B	C	D	E	F
Größe	WA-200	30.5	47.5	89	148.5	36	86
	WA-200 WB	30.5	47.5	89	148.5	36	86
	WA-101	27	44.5	85.5	147	36	86
	WA-101R	27	37.5	79	140.5	35	85
	LPA-200	30.5	47.5	89	148.5	36	86

### 3.2 AUSTAUSCH VON OPTIONALEN VERSCHRAUBUNGEN

Entfernen Sie die Luftpipette (Zerstäuberluft und Betriebsluft). Tauschen Sie den Luftpipette für die Zerstäuberluft (mit CAP markiert) mit der Verschraubung für Luftschlauch mit einem Außendurchmesser von  $\varnothing$  8 mm, Tauschen Sie den Luftpipette für die Betriebsluft (mit CYL markiert) mit der Verschraubung für Luftschlauch mit Außendurchmesser von  $\varnothing$  6 mm (im Lieferumfang der Automatik Lackierpistole enthalten).

**Achten Sie darauf, die Verschraubungen fest am Pistolenkörper anzuschließen.**

**HINWEIS:** Bei Verwendung eines 12 Meter Luftschlauchs muss der Innendurchmesser mindestens  $\varnothing$  8 mm (0,315) betragen, damit die Automatik Lackierpistole das korrekte Luftvolumen bei 0,7 bar (10 PSI) für die Zerstäubung hat.

## 4. BEDIENUNG

1. Stellen Sie den Betriebsluftdruck (CYL) auf 3 bis 4 bar (43 bis 57 PSI) ein.  
**HINWEIS:** Die Ventilöffnung im Dreizege-Magnetventil sollte mindestens  $\varnothing$  4 mm (0,157 in) betragen. Außerdem sollte die Länge des Betriebsluftschlauches maximal 10 Meter mit einem Innendurchmesser von mehr als  $\varnothing$  6 mm (0,236 in) betragen, um einen verzögerten Betrieb sowie jede Art von Ausfall zu vermeiden.
2. Obwohl der Zerstäubungsluftdruck je nach den Sprühbedingungen variiert, betätigen Sie den Kolben der Pistole mit dem vollständig geöffneten Flachstrahlregler und justieren Sie nach den Angaben in der obigen Tabelle. Nur bei der LPA-200, bei der es sich um eine HVLP Pistole handelt, muss der Lufteinlassdruck eingehalten werden, um einen Zerstäubungsdruck von 0,7 (10 PSI) zu erreichen.

3.	Die empfohlene Materialviskosität unterscheidet sich je nach Materialeigenschaft und -bedingungen. 15 bis 23 Sekunden / Ford Cup#4. ist empfehlenswert.
4.	Stellen Sie den Spritzabstand von Automatik Lackierpistole zum Werkstück so nah wie möglich innerhalb dieser Range ein: <b>WA-101 und WA-101R:</b> 150 ~ 200 mm (5,9 ~ 7,9 Zoll); <b>WA-200,WA-200WB und WA-200 ZP:</b> 200 ~ 250 mm (7,9 ~ 9,8 Zoll). <b>LPA-200:</b> 100 ~ 200 mm (3,9 ~ 7,9 Zoll). Da die LPA-200 eine HVLP Niederdruck Pistole ist, wird die korrekte Übertragungseffizienz nicht erreicht, wenn der Abstand zwischen der Pistole und dem Werkstück zu groß ist.

## 5. WARTUNG & INSPEKTION

	<b>Vor jeglichen Inspektions- und Wartungsvorgängen stets alle Angaben hinsichtlich SICHERHEITSHINWEISEN aufmerksam lesen und beachten.</b>
<b>Nie andere Bauteile oder Ersatzteile verwenden, die nicht Originalteile von ANEST IWATA sind.</b>	
<b>Nie die Öffnungen der Luftdüse, der Flüssigkeitsdüse und des Flüssigkeitsnadelendes beschädigen.</b>	
<b>Die Pistole nie vollkommen in Flüssigkeiten wie Lösungsmittel eintauchen.</b>	
<b>Die Luftdüse nie in die Reinigungsflüssigkeit für einen langen Zeitraum auch während der Reinigung eingetaucht lassen.</b>	

### 5.1 VORGANG

	<b>Die Materialdurchgänge müssen nach jeder Verwendung der Pistole und besonders nach der Verwendung von Zwei-komponentenlacken sorgfältig gereinigt werden. Eine unvollständige Reinigung könnte zu einem fehlerhaften Spritzstrahl führen.</b>
<b>Alle Material- und Luftkappedurchgänge (1) reinigen. Eine Kleinmenge von Waschmittel verwenden, um die Lackdurchgänge zu reinigen. Eine unvollständige Reinigung könnte zu einem fehlerhaften Spritzstrahl führen.</b>	
<b>Alle Bereiche mit der im Lieferung enthaltenen in Waschmittel getränkten Bürste reinigen und mit einem saugfähigen Lappen trocknen. Die Pistole nie vollkommen in das Waschmittel eintauchen, da sie beschädigt werden könnte. Während der Reinigung achten Sie darauf, dass die Öffnungen des Luftdüsensets, des Flüssigkeitsdüsensets oder die Nadel nicht verkratzt werden.</b>	

### 5.2 DEMONTAGE UND MONTAGE

<b>VOR DER DEMONTAGE SÄUBERN SIE ALLE MATERIALFÜHRENDEN TEILE</b>	
1.	Entfernen Sie die Luftkappe (1) bei vollständig geöffneter Materialeinstellung, schrauben Sie die Sechskantmutter des Reglers ab, entfernen Sie die Materialeinstellung (9), die Feder Kolben (8) und die Feder Farbnadel (7), entfernen Sie dann die Nadel (2-2) in einer geraden Linie aus dem Pistolenkörper, um die Nadeldichtungspatrone (11) zu schützen. Achten Sie bei diesem Vorgang darauf, dass die Materialeinstellung (9) nicht plötzlich herausspringt, da diese stark von der Feder Farbnadel (7) und der Feder Kolben (8) gedrückt wird.
2.	Nach dem Entfernen der Nadel (2-2), schrauben Sie die Düse (2-1) ab und nehmen diese aus ihrem Sitz, entfernen Sie dann die Abdeckung (12) der Nadeldichtungspatrone, schrauben Sie die Sechskantmutter der Nadeldichtungspatrone (11) ab und nehmen Sie sie aus dem Pistolenkörper.
3.	Zum Entfernen des Kolbens (6-2) schrauben Sie den hinteren Teil der Düse (2-2) in den Kolben ziehen ihn dann aus dem Pistolenkörper heraus. Nur im Falle von WA-200 ZP den Extraktionsbolzen (17) verwenden, um den Kolben aus dem Pistolenkörper herauszuziehen. Achten Sie während dieses Vorgangs darauf, die Kolbendichtung (6-1) und den O Ring (5-3) nicht zu beschädigen. <b>WICHTIG: Während des Wiederausbaus des Kolbens (6-2) tragen Sie Pistolenfett auf die Kolbendichtung (6-1) und den O-Ring (5-3), um jegliche Behinderung in der Bewegung des Kolbens zu vermeiden.</b>
<b>WICHTIG: Den Zusammenbau in umgekehrter Reihenfolge wie die vorher beschriebene Demontage vornehmen.</b>	

### 5.3 WICHTIGE EMPFEHLUNGEN

	<b>Die Regulierung der Nadeldichtung (11) muss immer mit dem eingebauten Nadelset ausgeführt werden. Die Nadeldichtung mit der Hand schließen und danach sie mittels des geeigneten Schlüssels um ungefähr 1/6 Drehung (60 Grade) anziehen. Wenn Sie die Nadeldichtung (11) entfernen, lassen Sie kein Plastikstück der Nadeldichtung innerhalb des Pistolenkörpers.</b>
<b>WICHTIG: Ein übermäßiges Anschrauben der Nadeldichtung (11) kann die normale Bewegung des Nadelsets (2-2) verhindern. Das könnte einen Lackaustritt aus der Ende der Farbdüse (2-1) verursachen. Beim Prüfen der Bewegung des Nadelsets (2-2) sorgfältig regulieren. Wenn die Nadeldichtung zu viel angeschraubt ist, sie völlig aufschrauben und nochmals sorgfältig anschrauben.</b>	





Wenn Sie die Düse (2-1) und die Nadel (2-2) austauschen, überprüfen Sie die korrekte Verbindung beider, um während des Betriebs der Lackierpistole ein Auslaufen von Material aus der Düse zu vermeiden.

Achten Sie beim Schließen der Materialeinstellung (9) und der Düse (2-1) immer darauf, dass der Einstellknopf für die Materialzufuhr vollständig gelöst ist.

### 5.4 STANDARDINSPEKTIONEN & ERSETZUNGEN

ZU KONTROLLIERENDE TEILE	ZU ERSETZENDE TEILE
Alle Durchgangsöffnungen der Luftkappe (1) und der Farbdüse (2-1).	Bei Quetschungen oder Verformungen ersetzen.
Dichtung und O-Ring.	Bei Verformungen oder Verschleiß ersetzen.
Verluste aus der Bereiche der Sitze zwischen der Farbdüse (2-1) und der Farbnadel (2-2).	Ersetzen, wenn die Verluste auch nachdem das Farbdüse (2-1) und das Farbnadel (2-2) vollkommen gereinigt wurden, weiter anhalten. Werden nur die Farbdüse (2-1) und die Farbnadel (2-2) ersetzt, die korrekte Paarung beider überprüfen und sich vergewissern, dass keine eventuellen Verluste vorliegen.

### 6. FEHLERBEHEBUNG

PROBLEME	LÖSUNGEN	
<b>SPRITZPISTOLE SPRÜHT NICHT</b>		
	Materialeinstellung (9) geschlossen.	Überprüfen und einstellen.
	Öffnung der Farbdüse (2-1) verstopft.	Überprüfen und reinigen.
	Lackanhäufung zwischen Nadelset (2-2) und Nadeldichtung (11)	Überprüfen und reinigen.
<b>STOSSWEISER SPRÜHSTRAHL</b>		
	Falschluf aus der Farbdüse (2-1) und aus den Kegelsitzen des Pistolenkörpers.	Überprüfen, reinigen und wenn erforderlich ersetzen.
	Falschluf aus dem Nadeldichtung (11).	Festziehen.
	Falschluf aus dem Anschluss des Materialschlauchs.	Festziehen.
	Materialreste in der Luftkappe (1).	Reinigen.
<b>FEHLERHAFTER SPRÜHSTRAHL</b>		
	Farbdüse (2-1) oder Luftkappe (1) verkrüftet.	Sorgfältig reinigen.
	Farbdüse (2-1) oder Luftkappe (1) beschädigt.	Wenn erforderlich ersetzen.
	Farbdüse (2-1) gelöst.	Anziehen.
	Viskosität der Flüssigkeit zu hoch oder zu niedrig.	Den Lack verdünnen oder die Viskosität erhöhen.
	Die Lackdurchsatz ist zu hoch oder zu niedrig.	Den Materialeinstellung (9) einstellen, um den Durchsatz zu verringern oder zu erhöhen.
<b>UNDICHT</b>		
	Farbdüse (2-1), Nadelset (2-2) im Sitz verkrüftet, beschädigt oder abgenutzt.	Reinigen oder wenn erforderlich ersetzen.
	Materialeinstellung (9) gelöst.	Einstellen.
	Feder Farbnadel (7) abgenutzt.	Ersetzen.
	Farbdüse (2-1) gelöst.	Anziehen.
	Materialablagerung zwischen der Nadel (2-2) und der Nadeldichtungspatrone (11).	Überprüfen und reinigen Sie es.
	Kolben (6-2) verschmutzt, beschädigt, am Sitz verschlissen.	Reinigen oder ersetzen.
	Feder Kolben (8) ist verschlissen.	Ersetzen.
	Kolbendichtung (6-1) ist verschlissen.	Ersetzen.

## 7. ERSATZTEILLISTE

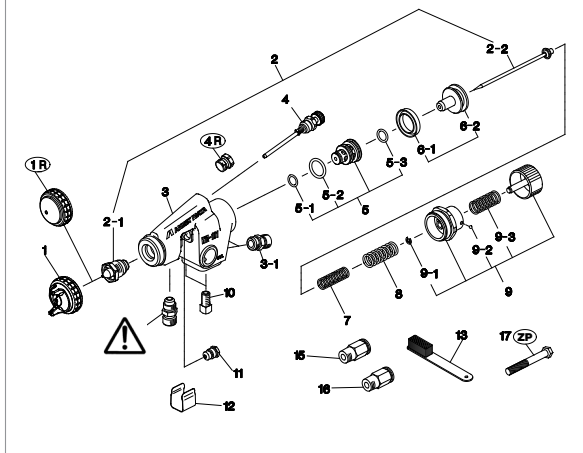

POS.	BESCHREIBUNG	
1	LUFTKAPPE	
1R	LUFTKAPPE (WA-101 R)	
2-1	DÜSE	•
2-2	NADEL	•
3	PISTOLENKÖRPER	
3-1	LUFTANSCHLUSSNIPEL	
4	FLACHSTRAHLREGLER	
4R	SCHRAUBE (WA-101 R)	
5	LUFTVENTILSITZ	
5-1		
5-2	O-RINGE	•
5-3		
6-1	KOLBENDICHTUNG	•
6-2	KOLBEN	
7	FEDER FARBNADEL	
8	KOLBENFEDER	
9	MATERIALEINSTELLUNG	
9-1	SPRENGRING	
9-2	KUGEL	
9-3	FEDER MATERIALEINSTELLUNG	
10	BOLZEN	
11	NADELDICHTUNGSPATRONE	•
12	ABDECKUNG	
13	FLACHBÜRSTE	
15	HALBANSCHLUSS Ø 6 (CYL)	
16	HALBANSCHLUSS Ø 8 (CAP)	
17	EXTRAKTIONSBOLZEN (WA-200 ZP)	
•	Die gekennzeichneten Teile sind Verschleiß unterworfen.	

### KOMBINATIONEN FARBDÜSE- UND FARBNADEL

MODELLE	Farbdüse		Farbnaedel
	Größe ø mm	Marke	Marke
<b>WA-101</b>			
WA-101	0.8 (0.031)	W101/08	WA12
WA-101	1.0 (0.039)	W101/10	
WA-101 R	0.5 (0.020)	W101/05	WA05
<b>WA-200</b>			
WA-200	0.8 (0.031)	W200/08	WA12
WA-200	1.0 (0.039)	W200/10	
WA-200	1.2 (0.047)	W200/12	
WA-200	1.5 (0.059)	W200/15	WA15
WA-200	2.0 (0.079)	W200/20	WA20
WA-200	2.5 (0.098)	W200/25	WA25
<b>WA-200 WB</b>			
WA-200 WB	0.8 (0.031)	200WB/08	WA12
WA-200 WB	1.0 (0.039)	200WB/10	
WA-200 WB	1.2 (0.047)	200WB/12	
WA-200 WB	1.4 (0.055)	200WBS1/14	WA15
WA-200 WB	1.6 (0.063)	200WB/16	
<b>WA-200 ZP</b>			
WA-200 ZP	1.5 (0.059)	W200/15Z	----
WA-200 ZP	2.0 (0.079)	W200/20Z	
WA-200 ZP	2.5 (0.098)	W200/25Z	
<b>LPA-200</b>			
LPA-200	1.8 (0.071)	L200/12	WA12



**ENTFERNEN SIE NIE-MALS DEN MATERIALANSCHLUSSNIPEL VOM PISTOLENKÖRPER.** Sämtliche Störungen, die durch das Entfernen der vorgenannte Teil entstehen, werden nicht durch die Garantie abgedeckt. Sofern ein Austausch erfolgen muss, kontaktieren Sie bitte direkt unseren Technischen Service.



Es wird gebeten, bei der Bestellung stets das Pistolenmodell, den Namen des Ersatzteils mit dem numerischen Bezug, das Kennzeichen der Luftdüse, der Farbdüse und der Farbnaedel anzugeben.







	Läs först dessa instruktioner innan du börjar med installation, igångsättning, justering eller utför underhåll på pistolen. Bevara sedan dessa instruktioner för framtida bruk.
  II 2G X	Automatisk sprutpistolen <b>ANEST IWATA</b> uppfyller föreskrifterna i <b>ATEX-direktivet 2014/34/EU</b> .
Skydds nivå: kategori II 2G X. Lämpad för bruk i Zon 1 och i Zon 2.	
X-märkning: Eventuell statisk elektricitet hos pistolen ska urladdas via jordning genom den ledande luftslangen såsom föreskrivet.	

	Respektera <b>ALLTID</b> alla varningar vad gäller säkerhetsföreskrifterna i denna bruksanvisning.		
Symbol	BETYDELSE	RISKNIVÅ	KONSEKVENS
	<b>VARNING</b>	POTENTIellt FARLIG SITUATION	Allvarliga risker för operatörens hälsa och liv.
	<b>OBSERVERA</b>		Måttliga risker för produkten och operatören.
	<b>VIKTIGT</b>		Materialsador.

## 1. TEKNISKA SPECIFIKATIONER

MODELLER	WA-200	WA-200 WB	WA-200 ZP	WA-101	WA-101 R	LPA-200
Max. arbetstryck:	7.0 bar (100 PSI)					
Ljudnivå (LAeqT)*:	81.2 dB(A)	76.8 dB(A)	79.0 dB(A)	78.7 dB(A)	62.8 dB(A)	76.9 dB(A)
Anslutning tryckluft:	G1/4"					
Anslutning färg:	G1/4"	G1/4"	G3/8"	G1/4"	G1/4"	G3/8"
Temperaturområde:	Miljö 5 ~ 40 °C - Luft/Färg 5 ~ 43 °C					
*Mät punkt: 1 meter bakom sprutpistolen, vid 1,6 meters höjd.						

### 1.1 TEKNISKA DATA

MODELLER							
<b>WA-200 WB</b>							
WA-200 WB-081P	0.8	WB1	1.6	200	340	360	470
WA-200 WB-101P	1.0			250			
WA-200 WB-121P	1.2			300			
WA-200 WB-141P	1.4						
WA-200 WB-161P	1.6						
<b>WA-200</b>							
WA-200-062	0.6	LV2	2.0	255	270	280	500
WA-200-084	0.8						
WA-200-104	1.0						
WA-200-124	1.2						
WA-200-154	1.5						
WA-200-082P	0.8	G2P	3.0	500	530	400	
WA-200-102P	1.0						
WA-200-122P	1.2						
WA-200-152P	1.5						
WA-200-202P	2.0						
WA-200-251P	2.5	W1		360	320	330	
<b>WA-200 FLAT AND THIN® (Platt Sprutbredd)</b>							
WA-200-066P FT	0.6	FT6	1.8	80	170	140	550
WA-200-086P FT	0.8			100	185	150	
WA-200-106P FT	1.0			120	200	160	
WA-200-126P FT	1.2			140	220	180	
<b>WA-200 ZP (för Slipmedel Färg)</b>							
WA-200-151ZP	1.5	R1Z	3.5	760	500	370	470
WA-200-201ZP	2.0						
WA-200-251ZP	2.5						
<b>WA-101</b>							
WA-101-082P	0.8	E2P	3.0	150	270	190	460
WA-101-102P	1.0	E2P		200	270	220	
WA-101-101P	1.0	E1		100	90	140	
WA-101-132P	1.3	H2		250	260	230	
<b>WA-101 R (Rund Sprutbredd)</b>							
WA-101R-05P	0.5	RP	3.0	20	40	35	440
<b>LPA-200 HVLP</b>							
LPA-200-122P	1.2	G2	2.0	500	500	300	500
LPA-200-S5-12P	1.2	G2	2.0	250	560	250	

## 2. SÄKERHETSFÖRESKRIFTER

<b>BRAND OCH EXPLOSION</b>	
Använd aldrig <b>LÖSNINGSMEDEL MED HALOGENKOLVÄTEN</b> , som kan orsaka skador och upplösning av delarna i aluminium hos själva pistolkroppen beroende på kemiska reaktioner. <b>ICKE KOMPATIBLA LÖSNINGSMEDEL:</b> metylenklorid, diklormetan, 1,2 diklormetan, koltetraklorid, trikloretylen, 1.1.1- triklorethan.	   
<b>Närvaron av öppna lågor och gnistframkallning är strängt förbjudna.</b> De brukade produkterna kan vara mycket lättantändliga och kan medföra allvarliga brandrisker. Undvik alla aktiviteter som kan medföra risk för brand såsom rökning, gnistframkallning samt aktiviteter som kan leda till elektriska risker.	
<b>Koppla sprutpistolen ordentligt till en jordad ledning via en ledad luftslang. (&lt; 1MΩ).</b> Kontrollera stabiliteten hos den jordade ledningen med jämna mellanrum.	
<b>HÄLSORISKER</b>	
Använd sprutpistolen i lokaler med god ventilation, t.ex i en sprutbox. En felaktig eller otillräcklig ventilation kan orsaka förgiftning från organiska tvättmedel och kan vara orsak till brand.	  
<b>Bär alltid skyddskläder (skyddsglasögon, ansiktsmask, skyddshandskar).</b> Undvik kontakt med frätande medel som kan orsaka inflammation hos ögon och hud. Om det skulle inträffa en olyckshändelse, även av liten entitet, bör man omgående kontakta en läkare.	
<b>Vid behov, utnyttja hörselskydd för akustisk isolering.</b> Beroende på bruksvillkor samt själva arbetslokalen utformning kan bullernivån överstiga 80 dB(A).	
<b>RISKER VID FELAKTIGT BRUKANDE</b>	
Rikta <b>ALDRIG</b> pistolen mot en person eller ett djur.	
<b>Överskrid ALDRIG det maximala körtrycket eller lokalens maxtemperatur.</b>	
<b>Stäng av och töm ledningarna på kvarliggande lufttryck samt material innan man påbörjar rengöringsingrepp, nedmontering eller underhåll.</b> Kvarliggande tryck kan medföra risk för kroppsskador som orsakas av felaktiga ingrepp eller utsläpp av de vätskor som brukats för rengöringen. För att tömma kvarliggande tryck, stäng av frammatningen av tryckluften samt materialet. Mata därefter pistolen med luft och töm den på det kvarliggande materialet via sprutnålen. Detta ingreppet kommer att leda till en omedelbar avstanning av den komprimerade luften.	
<b>Spetsen på sprutnålen är mycket vass.</b> För att undvika skador, rör inte vid spetsen vid underhålls-ingreppet.	
<b>Spruta aldrig födoämnen eller kemikalier med sprutpistolen.</b> Blandningen med främmande substanser kan medföra frätningsskador i ledningarna, med följande skador på själva pistolen samt hälsorisker.	
<b>Modifiera aldrig sprutpistolen,</b> för att undvika skador hos denna som kan ifrågasätta kvaliteten hos resultatet.	
<b>I händelse av felfunktion ska sprutarbetet omedelbart avbrytas och felsökning skall utföras.</b> Använd inte produkten tills dess felet har åtgärdats.	
<b>Gå aldrig in i utrustningens arbetsområde (såsom robotar, reciprokatorer osv.), förrän dessa har avaktiverats.</b> I annat fall kan kontakten med maskiner i rörelse leda till olycksfall och skador.	

## 3. UPPKOPPLING

	För att mata sprutpistolen, använd torr filterad luft.
<b>När man använder pistolen för första gången efter inköpet, rengör först materialpassager-na genom att spruta ett kompatibelt tvättmedel för att ta bort rostskyddsolja.</b>	
<b>Använd en elektromagnetisk ventil med tre gånger, vars interna diameter måste överstiga 4 mm, samt en luftslang med en intern diameter som överstiger 6 mm och som inte får vara längre än 10m.</b> En elektromagnetisk ventil med en för liten diameter och en luftslang som överstiger 10 meter i avståndet mellan ventilen och pistolen kan orsaka förseningar i utförandet.	
<b>Fäst slangen ordentligt till pistolen för att undvika att den lossnar eller läcker under brukandet och därmed kan leda till allvarliga kroppsskador.</b>	

1.	Fäst pistolen på fäste, ställ in sprutriktningen och blockera pistolen i den korrekta positionen med hjälp av fästbultar.
2.	Koppla noggrant luftslangen till sidan för luftinsläppet på den finfördelade enheten (betecknad CAP) och luftslangen till driftsluften på sidan till driften (betecknad CYL).
3.	Koppla noggrant materialslangen till färgnippeln.
4.	Mata den automatiska sprutpistolen med rengöringsvätska och spruta för att rengöra materialgångarna.
5.	Mata därefter den automatiska sprutpistolen med material, kontrollera sprutflödet och reglera luftkvantiteten, kvantiteten frammatat material samt sprutbredden i enlighet med personliga behov.

### 3.1 ANSLUTNING AV LUFT- OCH FÄRGLINJEN

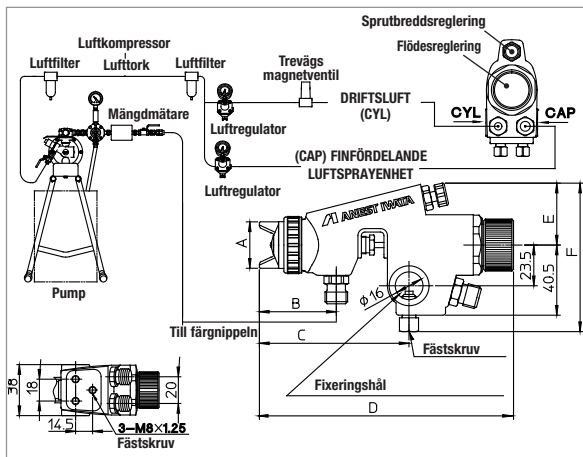

Dimensioner	MODELLER	A	B	C	D	E	F
	WA-200	30.5	47.5	89	148.5	36	86
	WA-200 WB	30.5	47.5	89	148.5	36	86
	WA-101	27	44.5	85.5	147	36	86
	WA-101R	27	37.5	79	140.5	35	85
	LPA-200	30.5	47.5	89	148.5	36	86

### 3.2 BYTE AV VALFRI LUFTKOPPLING

Ta bort luftnippelarna för sönderdelningsluften och manöverluften från pistolen. Byt luftnippel för sönderdelningsluften (CAP-märkt) med luftkoppling passande luftslang med en yttre diameter på 8 mm och luftnippel för manöverluften (CYL-märkt) med luftkoppling passande luftslang med en yttre diameter på 6 mm, vilka följer med sprutpistolen.

**Säkerställ att luftkopplingarna är ordentligt anslutna till pistolkroppen.**

**NOTERA:** Vid användande av en 12 m lång luftslang (39.4 ft), måste den inre diametern vara minst 8 mm (0.315), så att pistolen får rätt luftvolym för finfördelning vid 0,7 bar (10 PSI) inuti luftkappan.

### 4. TILLVÄGAGÅNGSSÄTT

1.	Justera manöverlufttrycket från 3 till 4 bar (43 till 57 PSI).
<b>NOTERA:</b> Ventilöppningen inuti trevägs magnetventilen ska ha en diameter på minst 4 mm (0,157 in). Dessutom ska luftslangens längd vara max 10 m (32,8 ft) med en inre diameter på mer än 6 mm (0,236 in) för att undvika försenad drift och annan form av misslyckande.	
2.	Eftersom atomiserande lufttryck varierar beroende på sprayförhållanden, skruva på ratten för att justera kolven på pistolen med sprutbreddsventilen helt öppet och justera enligt vad som anges i ovanstående specifikationstabell. Endast när det gäller LPA200, som är en HVLP pistol, är det nödvändigt att följa indikationen av luftinloppstryck för att erhålla ett fördelningstryck inom 0,7 (10 PSI) bar inuti luftkappan.



3.	Rekommenderad viskositet för färgen varierar beroende på färgens egenskaper samt gällande lackeringsförhållande. En viskositet på mellan 15 och 25 sek/Fordkopp nr 4 rekommenderas.
4.	Fastställ lämpligt lackeringsavstånd mellan pistol och arbetsstycke, det rekommenderade avståndet är: <b>WA-101</b> och <b>WA-101R</b> : 150~200 mm (5.9~7.9 in); <b>WA-200</b> , <b>WA-200WB</b> och <b>WA-200 ZP</b> : 200~250 mm (7.9~9.8 in). När det gäller <b>LPA-200</b> : 100~200 mm (3.9~7.9 in). <b>LPA-200 HVLP</b> är en automatisk pistol med lågt tryck, vilket gör att om avståndet mellan pistolen och arbetsstycket är för långt, kommer den korrekta överföringseffektiviteten inte att uppnås.

## 5. UNDERHÅLL OCH INSPEKTION

	Innan man utför underhållsinsrepp eller inspektioner bör man alltid först läsa igenom och noggrant följa alla anvisningar som ges i Säkerhetsföreskrifterna.
Använd aldrig komponenter eller reservdelar som inte är original från ANEST IWATA.	
Skada aldrig hålen på luftmunstycket, materialmunstycket eller sprutnålens topp.	
Doppa aldrig ned pistolen helt och hållet i vätskor av typen lösningsmedel.	
Blöttlägg aldrig luftmunstycket i rengöringsvätskor under längre intervall, ej heller under själva rengöringen.	

### 5.1 RENGÖRINGSPROCEDURE

	Materialgångarna måste noggrant rengöras efter varje användningstillfälle och speciellt efter sprutarbeten med bikomponentslack. En otillräcklig rengöring kan leda till fel i sprutbredden.
Rengör alla materialpassager och luftmunstycket (1). Spruta en liten kvantitet tvättmedel för att rengöra flödesgångarna. En otillräcklig rengöring kan medföra fel i sprutbredden.	
Rengör varje sektion med en liten borste doppad i tvättmedeloch torka av med en absorberande trasa. Doppa aldrig hela pistolen i tvättmedel eftersom detta kan leda till skador på produkten. Under rengöringsoperationerna, undvik att skrapa ytorna runt hålen till luftmunstycket, materialmunstycket samt sprutnålen.	

### 5.2 NED- SAMT ÅTERMONTERING

<b>INNAN NEDMONTERING, RENGÖR VÄTSKEPASSAGEN.</b>	
1.	Ta bort luftmunstycket (1) med inställningen för vätskejustering helt öppen. Skruva loss sexkantsmuttern från justeringen och ta bort vätskejusteringssetet (9), kolvfjäders (8) och färgnålsfjäders (7), ta sedan ut nålsetet (2-2) i en rak linje från pistolen för att skydda färgnålspackningssetet (11). Under hanteringen – kontrollera att färgnålsstyrningssetet (9) inte plötsligt flyger iväg då trycket är hårt från färgnålsfjäders (7) och kolvfjäders (8).
2.	Efter att nålsetet (2-2) tagits bort, skruva loss färgmunstycket (2-1) och ta bort det från dess säte. Ta bort skyddshöljet (12) på nålpackningen, skruva loss sexkantsmuttern från nålpackningen (11) och ta bort det från pistolkroppen.
3.	För att avlägsna kolvuppsättningen (6-2), skruva in den bakre delen av färgnålssetet (2-2) i kolven och dra ut den från pistolen. Alleen in de zaak van <b>WA-200 ZP</b> , använd extraktionsbulsten (17) för att dra ut kolven från pistolen. Var försiktig så att du inte skadar kolvpackningen och O-ringen vid hanteringen. <b>VIKTIGT: Under återmonteringen av kolven (6-2), applicera fett på kolvpackningen (6-1) och O-ringen (5-3) för att undvika hinder för kolvens rörelse.</b>
<b>VIKTIGT: FÖR ÅTERMONTERING, GENOMFÖR PROCEDUREN I OMVÄND ORDNING (3-2 OCH 1).</b>	

### 5.3 VIKTIGA REKOMMENDATIONER

	<b>Regleringen av sprutnålspackningen (11)</b> måste alltid utföras med sprutnålen (2-2) monterad och på följande sätt: stäng av för hand och skruva därefter åt med den bifogade ställskruvsnyckeln cirka 1/6 varv (60 grader). När man lossar på sprutnålspackningen (11), se till att den lilla plastdelen hos sprutnålspackningen (11) inte blir kvar inuti sätet.
<b>VIKTIGT:</b> En för hård åtdragning av sprutnålspackningen (11) kan medföra förhindring av sprutnålens rörelse (2-2), med ett materialläckage som följd från materialmunstyckets ände (2-1). Reglera långsamt och kontrollera samtidigt sprutnålens (2-2) rörelse. Om den skulle visa sig för hårt åtdragen, skruva loss den helt och hållet och skruva sedan noggrant fast den igen.	

**Vid byte av färgmunstycket (2-1) och färgnålsset (2-2),** kontrollera att kopplingarna sitter rätt på båda, för att undvika färgläckage från färgmunstycket vid användande av sprutpistolen.

**Vid stängande av färgnålsstyrningssetet (9) och färgmunstycket (2-1),** kontrollera att färgnålsjusteringen är helt lossad.

## 5.4 STANDARDINSPEKTIONER OCH -BYTEN

DELAR SOM SKA KONTROLLERAS	DELAR SOM SKA BYTAS UT
Alla passager till luftmunstycke (1) och materialmunstycke (2-1).	Byt ut om klämda eller deformerade.
Packningar och O-ringar	Byt ut om de är deformerade eller utslitna.
Läckage från sätena mellan materialmunstycke (2-1) och sprutnålen (2-2).	Byt ut delarna om läckaget inte ens upphör efter att färgmunstycket (2-1) och färgnålen (2-2) har rengjorts fullständigt. Om du endast byter ut färgmunstycket (2-1) och färgnålen (2-2), kontrollera sammankopplingen av båda och försäkra dig om att inga eventuella läckage förekommer.

## 6. PROBLEM, ORSAKER OCH ÅTGÄRDER

PROBLEM	ÅTGÄRDER
<b>FÄRGEN SPRUTAR INTE UT</b>	
	Nålens ställskruv (9) är åtdragen. Kontrollera och reglera.
	Materialmunstyckets (2-1) håll är tilltäppt. Kontrollera och rengör.
	Samling av lack mellan nålen (2-2) och nålpackningen (11). Kontrollera och rengör.
<b>OJÄMN FINFÖRDELNING</b>	
	Luft läcker ut från materialmunstycket (2-1) och de koniska sektionerna på pistolkroppen. Kontrollera, rengör och byt ut om nödvändigt.
	Luft läcker från sprutnålspackningen (11). Drag åt.
	Luft läcker ut från kopplingen med materialnippeln. Drag åt.
	Färgrester i luftmunstycket (1). Rengör.
<b>SPRUTBILDSDEFEKTER</b>	
	Materialmunstycket (2-1) eller luftmunstycket (1) är tilltäppta med material. Rengör noggrant.
	Materialmunstycket (2-1) eller luftmunstycket (1) är skadade. Byt ut om nödvändigt.
	Materialmunstycket (2-1) är felaktigt fastsatt. Lossa för att rengöra sätet.
	Flödets viskositet är för hög eller för låg. Späd flödet eller öka viskositeten.
	Materialet flödar för snabbt eller för långsamt. Justera ställskruven (9) för att minska eller öka flödet.
<b>FÄRG LÄCKER UT</b>	
	Materialmunstycket (2-1), och sprutnålen (2-2) är tilltäppta, skadade eller utslitna i sina respektive säten. Rengör och byt ut om nödvändigt.
	Sprutnålens ställskruv (9) sitter lös. Drag åt.
	Sprutnålsfjädern (7) är utsliten. Byt ut.
	Materialmunstycket (2-1) lös. Drag åt.
	Avlagring av färg mellan färgnålen (2-2) och nålpackningssatsen (11). Kontrollera och rengör.
	Kolvsetet (6-2) är smutsigt, skadat eller har ett slitet säte. Rengör eller byt ut.
	Kolvfjädern (8) är sliten. Byt ut.
	Kolvpackningen (6-1) är sliten. Byt ut.

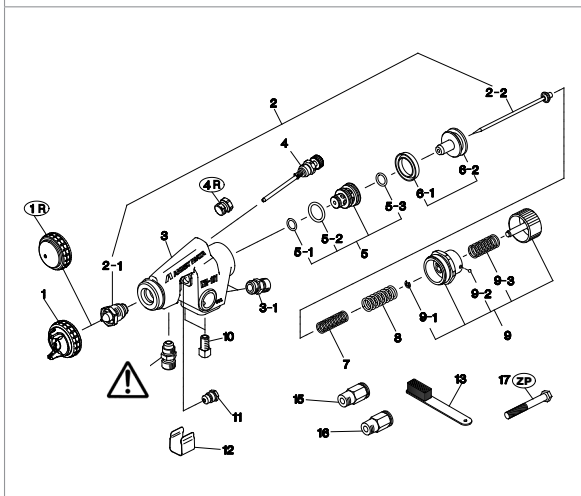
**7. RESERVD ELSLISTA**

POS.	RESERVD ELSFÖRTECKNING
1	LUFTMUNSTYCKE
1R	LUFTMUNSTYCKE (WA-101 R)
2-1	FÄRGMUNSTYCKE
2-2	FÄRGNÅL
3	PISTOL KROPP
3-1	LUFTNIPPELN
4	STÄLLSKRUV FÖR SPRUTBILD
4R	SKRUVLOCK (WA-101 R)
5	LUFTVENTILSSÅTE
5-1	
5-2	'O' RING
5-3	
6-1	KOLVTÄTNING
6-2	KOLV
7	FÄRGNÅLSFJÄDER
8	KOLVFJÄDER
9	FÄRGNÅLSJUSTERING
9-1	LÅSRING
9-2	KULA
9-3	MATERIALJUSTERINGSFJÄDER
10	FIXERINGSSKRUV
11	FÄRGNÅLPACKNINGSMUTTER
12	SKYDD
13	BORSTE
15	SNABBKOPPLING Ø 6 (CYL)
16	SNABBKOPPLING Ø 8 (CAP)
17	EXTRAKTIONSBULTEN
	De markerade delarna utsätts för slitage.

**FÄRGMUNSTYCKE - FÄRGNÅL KOMBINATIONER**

MODELLER	FÄRGMUNSTYCKE		FÄRGNÅL
	Storlek ø mm	Märkning	Märkning
<b>WA-101</b>			
WA-101	0.8 (0.031)	W101/08	WA12
WA-101	1.0 (0.039)	W101/10	
WA-101 R	0.5 (0.020)	W101/05	
<b>WA-200</b>			
WA-200	0.8 (0.031)	W200/08	WA12
WA-200	1.0 (0.039)	W200/10	
WA-200	1.2 (0.047)	W200/12	
WA-200	1.5 (0.059)	W200/15	WA15
WA-200	2.0 (0.079)	W200/20	WA20
WA-200	2.5 (0.098)	W200/25	WA25
<b>WA-200 WB</b>			
WA-200 WB	0.8 (0.031)	200WB/08	WA12
WA-200 WB	1.0 (0.039)	200WB/10	
WA-200 WB	1.2 (0.047)	200WB/12	
WA-200 WB	1.4 (0.055)	200WBS1/14	WA15
WA-200 WB	1.6 (0.063)	200WB/16	
<b>WA-200 ZP</b>			
WA-200 ZP	1.5 (0.059)	W200/15Z	----
WA-200 ZP	2.0 (0.079)	W200/20Z	
WA-200 ZP	2.5 (0.098)	W200/25Z	
<b>LPA-200</b>			
LPA-200	1.8 (0.071)	L200/12	WA12



**SETA ALDRIG BORT FÄRGNIPPELN FRÅN PISTOLKROPPEN!** Fel som uppstår på grund av avlägsnande av dessa delar, kommer inte att täckas av garantin. Vid utbyte av delarna, kontakta din tekniska service direkt.



När beställningar gör ska du komma ihåg att ange pistolens modell, reservdelens benämning tillsammans med referensnummer, initialerna för luftmunstycket, färgmunstycket och färgnålen.

AI Worldwide



#### ■ EUROPE

ANEST IWATA Italia S.r.l.  
Chieri (TO) - ITALY  
info@anest-iwata-it.com  
www.anest-iwata-coating.com

ANEST IWATA Deutschland GmbH  
Leipzig - GERMANY  
info@anest-iwata-de.com  
www.anest-iwata.de

ANEST IWATA France S.A.  
Saint Quentin Fallavier, Lyon - FRANCE  
info@anest-iwata-fr.com  
www.anest-iwata.fr

ANEST IWATA U.K. Ltd.  
St. Neots Cambridgeshire - ENGLAND  
info@anest-iwata-uk.com  
www.anest-iwata.co.uk

ANEST IWATA Iberica S.L.U.  
Saint Adrià del Besos - Barcelona - SPAIN  
info@anest-iwata-ib.com  
www.anest-iwata.es

ANEST IWATA Scandinavia AB.  
Partille, Göteborg - SWEDEN  
info@anest-iwata-se.com  
www.anest-iwata.se

ANEST IWATA Polska Sp. Z o.o.  
Jasin / Swarzędz - POLAND  
info@anest-iwata-pl.com  
www.anest-iwata.pl

#### ■ NORTH AMERICA

ANEST IWATA USA Inc.  
West Chester - Ohio - U.S.A.  
inquiry@anestiwata.com  
www.anestiwata.com

#### ■ SOUTH AMERICA

ANEST IWATA DO BRASIL COMERCIAL Ltda.  
Sao Paulo - BRAZIL  
contato@anest-iwata.net.br  
www.anest-iwata.net.br

#### ■ AUSTRALIA

ANEST IWATA Australia Pty Ltd.  
Sidney - AUSTRALIA  
info@anest-iwata.com.au  
www.anest-iwata.com.au

#### ■ SOUTH AFRICA

ANEST IWATA South Africa Pty Ltd.  
Johannesburg - REPUBLIC OF SOUTH AFRICA  
www.anest-iwata.co.za

#### ■ ASIA

ANEST IWATA Coating Solutions Corporation  
Yokohama - JAPAN  
www.anest-iwata.co.jp

ANEST IWATA KOREA Corporation  
Ansan City - KOREA  
inquiry@aikr.co.kr  
www.aikr.co.kr

ANEST IWATA Motherson Coating Equipment Ltd.  
Noida - INDIA  
sales@aim.motherson.com  
www.motherson.com/anest-iwata-motherson.html

ANEST IWATA Russia LLC  
Moscow - RUSSIA  
tam@anestiwata.ru  
www.anestiwata.ru

ANEST IWATA Shanghai Corporation  
Shanghai - CHINA  
customer@anest-iwata-sh.com  
www.anest-iwata-sh.com

ANEST IWATA Taiwan Corporation  
Hu-Kuo - TAIWAN R.O.C.  
service@anestiwata.com.tw  
www.anestiwata.com.tw

ANEST IWATA Vietnam CO. Ltd.  
Ho Chi Minh City - VIETNAM  
info@anest-iwata.vn  
www.anest-iwatasoutheastasia.com

PT. ANEST IWATA Indonesia  
Jakarta - INDONESIA  
www.anest-iwatasoutheastasia.com

ANEST IWATA Southeast Asia CO. Ltd.  
Bangkok - THAILAND  
info@anest-iwata.co.th  
www.anest-iwatasoutheastasia.com

**HEADQUARTER:**  
ANEST IWATA  
Corporation  
Yokohama - JAPAN  
www.anest-iwata.co.jp